

Hoisting and Rigging Fundamentals for Riggers and Operators

Pendant Control - Components

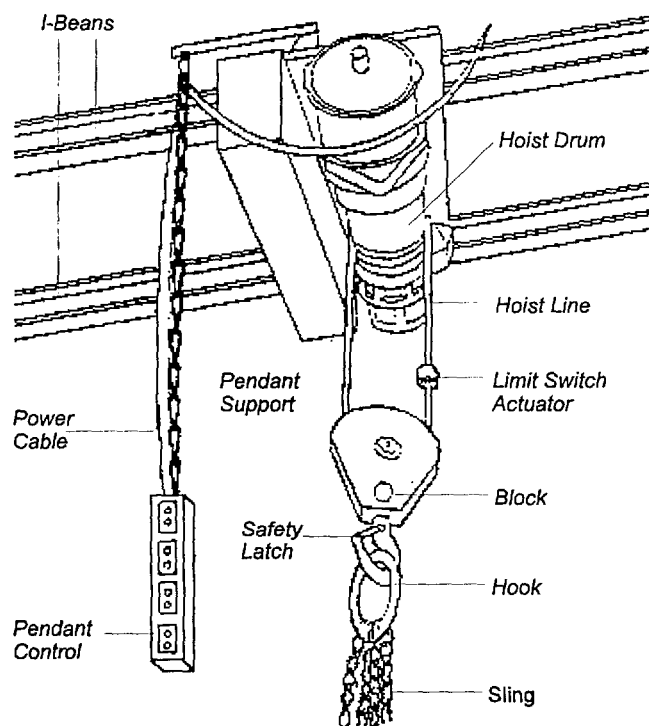

TR244C, Rev. 5
December 2002

TABLE OF CONTENTS

INTRODUCTION	ii
HOISTING AND RIGGING OBJECTIVES	1
WIRE ROPE SLINGS	2
SYNTHETIC WEBBING SLINGS	10
CHAIN SLINGS	14
METAL MESH SLINGS	18
SPREADER BEAMS	19
RIGGING HARDWARE	22
INSPECTION TAG	39
CRITICAL LIFTS	40
GENERAL HOISTING AND RIGGING PRACTICES	44
HAND SIGNALS	64
INCIDENTAL HOISTING OPERATOR OBJECTIVES	68
HOISTS	69
OVERHEAD AND GANTRY CRANES	71
MOBILE CRANES	77
APPENDIX	81

INTRODUCTION

HOISTING AND RIGGING PROGRAM

Safety should be the **first priority** when performing lifting operations. An understanding of the capabilities and limitations of the equipment will support this. The safety policy "*If It's Not Safe, Don't Do It*" is important not only for *your* safety, but the safety of *your coworkers*.

The material outlined in this manual outlines the requirements of the DOE Hoisting and Rigging program. It requires persons who **perform rigging or operate hoisting equipment** to be trained to ensure that the personnel are competent to perform the operation. The **qualification** is for a period the *three years*. The training requires a written exam and practical demonstration.

The requirements for **operator training and qualification** can be reviewed in the *DOE Hoisting and Rigging Manual*.

HOISTING AND RIGGING OBJECTIVES

KNOWLEDGE OBJECTIVES

- Explain the qualification requirements of the Rigging Training Program.
- Demonstrate how to calculate the load on the sling using the load angle factor for various load angles.
- Explain the proper use and limitations of the various rigging equipment and hardware (wire rope, synthetic web slings, shackles, eyebolts, hooks, etc.).
- Identify the components and describe the characteristics of wire rope and synthetic slings.
- Describe and state what an ordinary lift and critical lift is.
- Explain the responsibilities of the Person-In-Charge (PIC) and designated leader.
- Explain safe working practices to consider when performing hoisting and rigging.
- State the requirements for routine and periodic inspections.
- State the proper hand signals used during lifting operations.

WIRE ROPE SLINGS

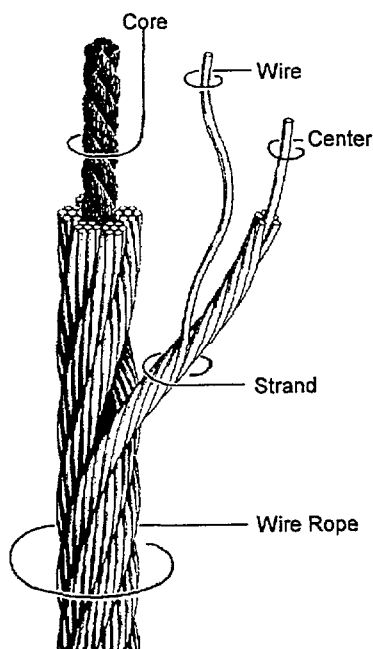

- 2 Wire rope is made up of three basic parts: the core, the wire, and the strand.

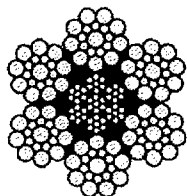

- 3 6 x 19 construction. The larger wires on the outside of each strand resist wear.

Wire Rope consists of three components (1):

The **CORE** is the center of the wire rope. The core serves as the foundation to hold the rope together.

There are **three types of cores**:

- ❑ *Fiber* - synthetic or sisal, which is the weakest,
- ❑ *Strand* - the core is a wire strand, just like the other strands of the rope.
- ❑ *Independent Wire Rope (IWRC)* - this is a separate wire rope. It is the strongest of the three types. The core provides 7-1/2% strength of the wire rope. This is the core used in the wire rope slings provided on site.

The **WIRE** is the basic unit of the wire rope. The wires form the strand. Most wire is high carbon steel, but other material types are available.

The **STRAND** is made up of a specific number of wires, laid helically around a wire core.

The most common type used at WVNS and in industry is 6 x 19. This is six strands comprised of approximately 19 wires (2), but may have 16 through 26 wires per strand. It has a good combination of flexibility and wear resistance.



4

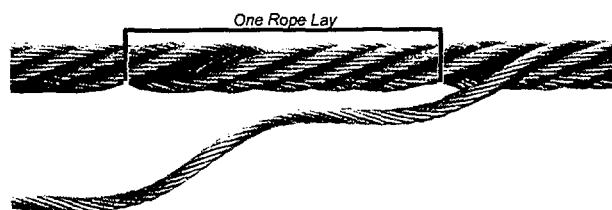

5

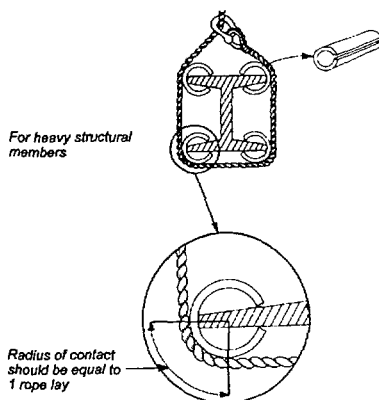

6

The term **rope lay** signifies the direction of rotation of the wires and the strand (3). Rotation is either to the right (clockwise) or left (counterclockwise). The standard is right regular lay. Left-lay rope is for special-purpose applications.

The **lay-length** is the distance measured along a rope in which a strand makes one complete revolution around the axis (4).

Wire rope slings have great strength combined with flexibility. They do not wear as rapidly and the indication of broken wires and appearances show its true condition.

Wire rope should be protected with softeners or blocking when used at corners or sharp bends. These softeners (5) are available at the tool crib. It's a good rule to make sure that the length of the arc of contact of the rope is at least equal to one rope lay (above seven times the rope diameter). This is the most common cause of damage to wire rope. Practice proper rigging and use softeners at corners or sharp bends. This is especially important when the load approaches the capacity of the rigging.

FATIGUE RESISTANCE

Fatigue resistance involves *metal fatigue* that make up a rope. To have high **fatigue resistance**, wires must be capable of bending repeatedly under stress - as when a rope passes over a sheave.

Increased fatigue is achieved in a rope design by using a large number of wires. It involves both the basic metallurgy and the diameters of wires.

In general, a rope made of many wires will have **greater** fatigue resistance than a same-size rope made of fewer larger wires, because *smaller wires have greater ability to bend* as the rope passes over sheaves or around drums.

To overcome the effects of fatigue, ropes must *never* bend over sheaves or drums with a diameter so small as to kink wires or bend them excessively. There are precise recommendations for sheave and drum sizes to properly accommodate all sizes and types of ropes.

Every rope is subject to metal fatigue from bending stress while in operation, and therefore, the rope's strength gradually diminishes as the rope is used.

STRENGTH

Wire rope **strength** is usually measured in **tons** of 2,000 pounds. The catalog term "**Breaking Strength**" -- is the nominal strength given the rope by engineers.

When put under tension on a test device, new ropes will actually *break* at a figure equal to, or higher than, the catalog figure.

The catalog figure applies to *new, unused* rope. A rope should *never* operate at the catalog strength.

During its useful life, a rope loses strength gradually due to natural causes such as surface wear and metal fatigue. Therefore, **a Factor of Safety** is applied during the selection of a rope in order to build service life into a rope installation.

Example: Factor of Safety

10 tons breaking strength = 2 tons SWL
5 factor of safety

This provides a factor of safety of 5. The breaking strength is divided by 5, to give the safe working load (SWL) of the hardware.

This provides for a margin of safety as new rigging hardware (slings, shackles, etc.) are used and wear. The safe working load (SWL) is the weight that is indicated on the inspection tag and is the load capacity for that item.

Inspection Tags:

Bridle Sling

Description _____ WVNS S/N _____ SWL _____ Inspection Date _____ Expiration Date _____	_____ _____ _____ _____ _____ 15° 30° 45° 60° MFG _____
--	--

Regular Straight Sling

Description _____ WVNS S/N _____ SWL _____ Inspection Date _____ Expiration Date _____	_____ _____ _____ _____ _____ Vert: SWL _____ Choker: SWL _____ Basket: SWL _____ MFG _____
--	---

Sling Eye Design

Sling eyes are designed to provide what amount to "small inverted slings" at the ends of the sling body. Therefore, the width of the eye opening will be affected by the same general forces which apply to legs of a sling rigged as a basket.

A sling eye should never be used over a hook or pin with a body diameter larger than the natural width of the eye. Never force an eye onto a hook.

On the other hand, the eye should always be used on a hook or pin with at least the nominal diameter of the rope—since applying the D/d Ratio shows an efficiency loss of approximately 50% when the relationship is less than 1/1.

D/d Ratios Apply to Slings

When rigged as a basket, **diameter** of the bend where a sling contacts the load can be a limiting factor on sling capacity. Standard D/d ratios—where "D" is the diameter of the bend, and "d" the diameter of the rope—are applied to determine efficiency of various sling constructions, as indicated at left:

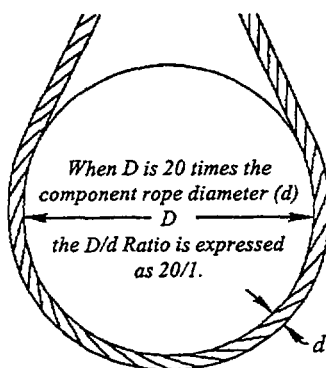

Choker Hitch Rated Capacity Adjustment

For wire rope slings in choker hitch when angle of choke is less than 135 degrees.

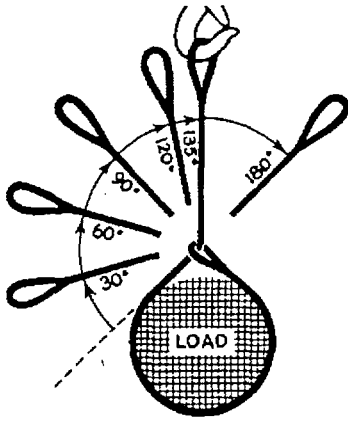

When a choker hitch is drawn tight at an angle of less than 120 degrees, the Choker Hitch Rated Capacity shown in the sling Rated Capacity Tables must be reduced to allow for loss of Rated Capacity. In controlled tests, where the angle was less than 120 degrees, the sling body always failed at the point of choke when pulled to destruction. Allowance for this phenomenon must be made anytime a choker hitch is used to shift, turn or control a load, or when the pull is against the choke in a multi-leg lift.

Choker Hitch Rated Capacity	
Angle of Choke in Degrees	Rated Capacity IWRC and FC rope Percent*
120-180	100
90-119	87
60-89	74
30-59	62
0-29	49

*Percent of sling rated capacity in a choker hitch.

6 Inspection

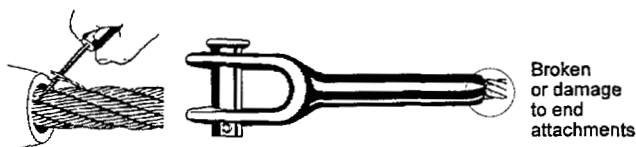
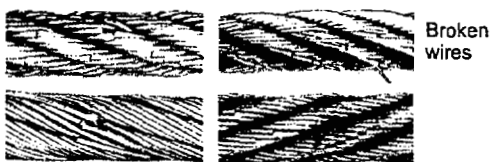

FREQUENT (PRE-USE) INSPECTION

Slings shall be visually inspected by the person using the sling each day of their use. This visual observation should be concerned with discovering damage that may be an immediate hazard.

Be sure to be aware of wire ropes in acid type environments. Such an environment can have a rapid corrosive affect on the wire rope.

Kinks

Kinking is caused by loops that have been drawn too tightly as a result of improper handling. Kinks are permanent distortions and will require the rope or the damaged section to be removed from service.

The following should be looked for in a pre-use inspection:

- 1) Broken wires.
- 2) Severe localized abrasion or scraping.
- 3) Kinking, crushing, birdcaging, or any other damage resulting in distortion of the rope structure.
- 4) Evidence of heat damage.
- 5) End attachments that are cracked, deformed, or worn to the extent that the strength of the sling is substantially affected.
- 6) Severe corrosion.

Review in Section 11.0 of the DOE H&R Manual. Subsection 11.3.2 Wire Rope Slings.

REVIEW QUESTIONS

WIRE ROPE

- 1. The core of wire rope is the center and serves to provide support and maintain the position of outer strands.**
 - A. True
 - B. False

- 2. Of the three types of wire rope cores, which is used most on site.**
 - A. Fiber
 - B. Independent wire rope (IWRC)
 - C. Super fiber
 - D. Strand

- 3. The classification 6x19 used in wire rope means:**
 - A. 6 fibers and 19 wires
 - B. 6 strands of 19 wires
 - C. 6 inches of 19 wires
 - D. 6 inches by 19 inch wire

- 4. A right lay, are strands laid in a _____ direction.**
 - A. Left
 - B. Counter clockwise
 - C. Right
 - D. B and C

SYNTHETIC WEBBING SLINGS

7



Synthetic web slings (7) have a number of advantages which include:

- Pliable, flexible, and tend to mold themselves to the shape.
- Minimize twisting and spinning.
- Do not rust and are non-sparking.
- Won't mar or crush the load.
- Are elastic and stretch.

There are two type of synthetic web slings at WVNS: nylon and polyester.

Nylon is the most common type used on site. It has an elastic stretch of 6% at noted capacity.

Polyester has less stretch, approximately 3 percent. The stretching of slings allows a cushion against sudden shock.

Both types are sensitive to heat and certain chemicals. Neither should be exposed to temperatures above 180 degrees F, and will soften on prolonged sunlight exposure. Therefore, the slings should be stored inside or under cover.

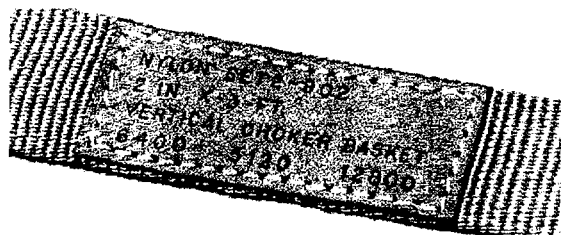

- 8 The permanent identification tag is sewn directly onto each synthetic web sling.

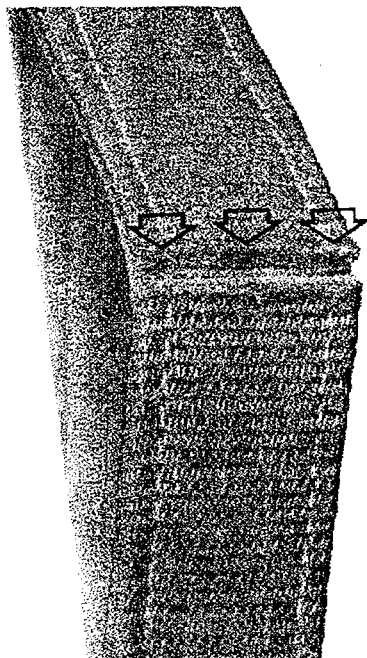

- 9 Red colored yarns indicate damage to the sling.

The size of the sling is determined by the width of the web. Each sling has a tag sewn to it with the type, size and rated capacities (8). Note the capacity for the vertical, choker and basket hitch are different.

The use of synthetic web slings in radiation areas should be avoided if possible. If it is necessary to use a nylon sling in a radiation area, the responsible person shall ensure radiation exposure to the sling does not exceed 100,000 rad during the life of the sling. Polyester fiber slings shall **never** be used in a radiation area.

FREQUENT (PRE-USE) INSPECTIONS

Slings shall be visually inspected for defects by the person using it before actual use.

Red colored yarns (9) are woven into the inner layer of most slings and, when exposed, indicate the sling should be **removed from service**.

Causes of wear or damage to synthetic web slings include (10):

Acid or Caustic Attack

Acid or caustic attack is normally evident by discoloration of the fabric. It can also cause the fabric to appear to be rotten.

10 Damage to Synthetic Slings

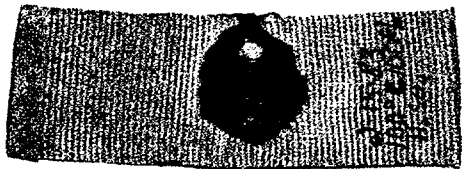

Acid Damage



*Cut and
Tensile
Damage*



*Abrasion
Damage*

Melting or Charring

Melting or charring on any part of the sling is sufficient enough reason to take a sling out of service. Damaged areas will be blackened, hard and melted like plastic, or speckled as when damaged from weld splatter.

Holes, Tears, Cuts or Snags

When holes, tears, cuts or snags appear on synthetic web slings, it is a judgement call on whether or not the sling is to be taken out of service. It must be determined how much of the inner thread damage there is to the sling, for they compose 80% of the sling's strength. This type of damage can be found on any part of the sling. When red guard warning yarn is exposed (red thread that is sewn in by the manufacturer) the sling must be taken out of service.

Excessive Abrasive Wear

Abrasive wear is characterized by frayed fibers on the surface webbing of the sling that hold in place the load-bearing (longitudinal) fibers. This type of abrasive wear is caused when a load slips in a sling or when slings are allowed to be pulled from under a load.

Damage to Synthetic Slings (*continued*)

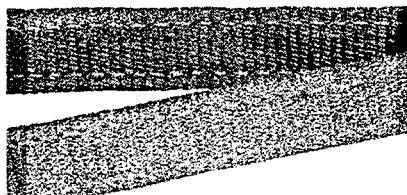

Watch stitching for broken or worn areas.

Knots reduce sling capacity by 50%.

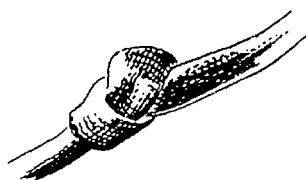

Broken or Worn Stitching

Slings must be inspected for broken or worn stitching in the load bearing splices of the sling. Broken or worn stitching in any other part of the sling is not of a critical nature. However, broken or worn stitching in load bearing splices can cause significant reduction of sling capacity.

Knots

Slings with knots in any part of them shall not be used. A knot in a sling can reduce the sling capacity up to 50% in the area of the knot.

End Fittings

Be sure to check for excessive pitting or corrosion, cracked, distorted or broken end fittings.

Check for any other visible damage that causes doubt as to the strength of the sling.

Review in Section 11.0 of the DOE H&R Manual. Subsection 11.3.5 - "Synthetic Web Slings."

REVIEW QUESTIONS**SYNTHETIC WEB SLINGS**

- 1. Most common synthetic web slings are made of which of the following:**
 - A. Polyester
 - B. Nylon
 - C. Acetone

- 2. Which of the following are advantages of synthetic web slings on wire rope.**
 - A. Won't mar or crush the load
 - B. Flexible
 - C. Lighter and easier to handle
 - D. All of the above

- 3. When the red yarn shows through a worn area on the sling it is still useable.**
 - A. True
 - B. False

- 4. Synthetic web slings cannot be cut if used around sharp-cornered objects without a protective cover.**
 - A. True
 - B. False

CHAIN SLINGS

11

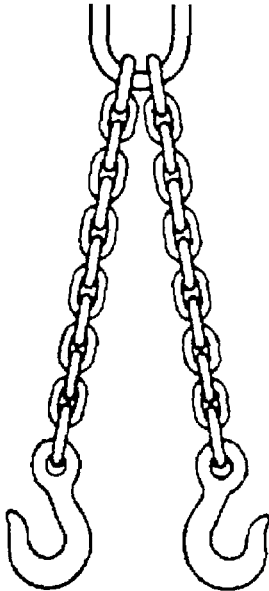

Chain slings (11) must be made of alloy steel (12).

Chain has the advantage of being better suited for lifting rough loads and withstanding high temperatures.

When possible use a wire rope sling instead of a chain sling. The failure of a single link of a chain can result in an accident. When overloaded it will stretch a bit and fail suddenly without warning.

Another difficulty of chain is that inspection is difficult due to the necessity to inspect each link.

FREQUENT (PRE-USE) INSPECTION

As required for all slings, Alloy Steel Chain slings shall be visually inspected by the person using the sling each day of its use. This visual observation should be concerned with discovering damage that may be an immediate hazard and a check of the equipment tag to verify the inspection due date.

Defects to look for on chain slings are as follows:

Length

Check overall length to see it matches up with the length on the tag. If a sling is shorter or longer (considering allowable tolerances) than the length on the tag. The sling must be taken out of service.

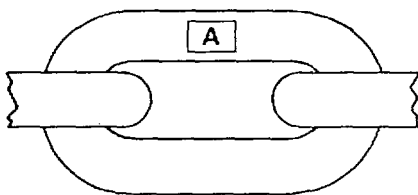

12 Alloy Steel Chain is stamped with an "A" on each link.

13 Link Inspection

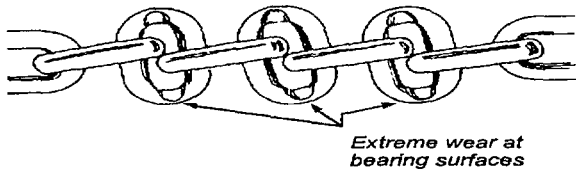
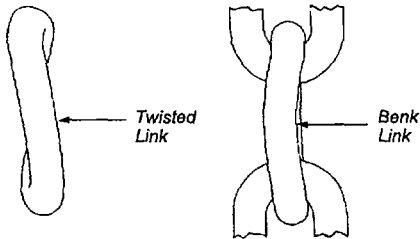
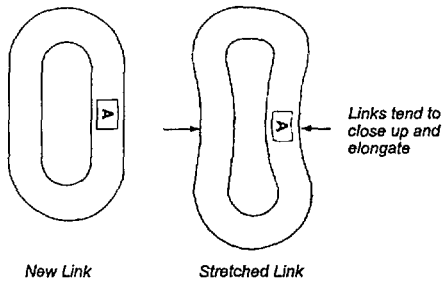
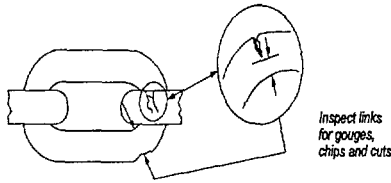

Master Link

Check the master link for elongation and wear on its bearing points.

Identification Tag

Be sure that the identification tag is legible with the proper information on it.

Connecting Link

Check the connecting link to see if it's bent, twisted, or deformed in any way.

Links (13)

- Chain links must be checked for cracks, nicks, and gouges.
- Elongation
- Bends or twists
- Heat damage
- Excessive wear
- Hooks

Hooks will be covered under rigging hardware.

Review Section 11.0 of the DOE H&R Manual, Subsection 11.3.3 "Steel Chain Slings."

REVIEW QUESTIONS

CHAIN SLINGS

- 1. Prior to use, the chain sling shall be visually inspected by conducting a link-by-link inspection.**
 - A. True
 - B. False

- 2. Shortening chain slings by bolting or inserting the tip of the hook into a link is permitted.**
 - A. True
 - B. False

- 3. To avoid brittle fractures, in temperatures less than 0°F, sudden loading of chain slings should be avoided.**
 - A. True
 - B. False

METAL MESH SLINGS

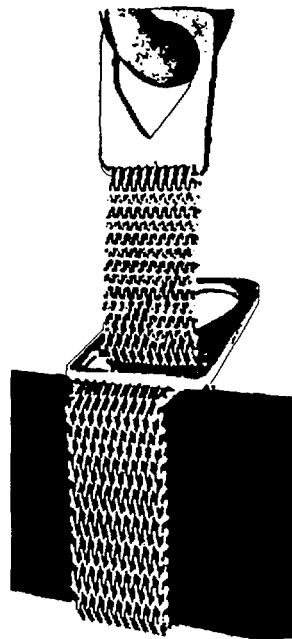

Metal mesh slings are designed for use when loads are abrasive, hot, or tend to cut web slings.

- 5) Distortion of the choker fitting so the depth of the slot is increased by more than 10%.
- 7) A 15% reduction of the original cross-sectional area of metal at any point around the hook opening of end fitting.
- 9) Cracked end fittings.

GENERAL REQUIREMENTS

Only **commercially manufactured** slings shall be used.

Attachments

End fittings shall be designed to ensure that the rated load of the sling is not reduced and the load is evenly distributed across the width of the fabric. No nonstandard (home-made) attachments shall be used.

FREQUENT (PRE-USE) INSPECTION

As with all slings, metal mesh slings shall be visually inspected by the person using it each day of its use. Metal mesh slings should be inspected for the following deficiencies:

- 1) Broken welds or broken brazed joints along the sling edge.
- 2) Broken wire in any part of the mesh.
- 3) Reduction in individual wire diameter of 25% due to abrasion or 15% due to corrosion.
- 4) Lack of flexibility due to distortion of the mesh.
- 6) Distortion of end fitting so the width of the eye opening is decreased by more than 10%.
- 8) Visible distortion of either end fitting out of its plane.

Metal Mesh Slings-Review in Section 11.0 of the DOE H&R Manual, Subsection 11.3.4, "Metal Mesh Slings."

GENERAL OPERATING PRACTICES OF SLINGS

- a. The weight of the load shall be within the rated capacity of the sling.
- b. Slings shall not be shortened or lengthened by knotting, twisting, with wire rope clips or other methods not approved by the sling manufacturer.
- c. Slings that appear damaged shall not be used.
- d. Sharp corners in contact with the sling should be padded to prevent damage to the sling.
- e. Shock loading should be avoided. Sudden starts and stops increase (out of all proportion to the load), stress in the sling and crane hoist rope.
- f. Slings should be stored in an area where they will not be subjected to mechanical damage, corrosive action, moisture, extreme heat, or kinking.
- g. In a choker hitch, wire rope slings shall be long enough so that the choker fitting will choke on the rope body and never on the fitting.
- h. Sling angles less than 45 degrees should be avoided.

SPREADER BEAMS

15

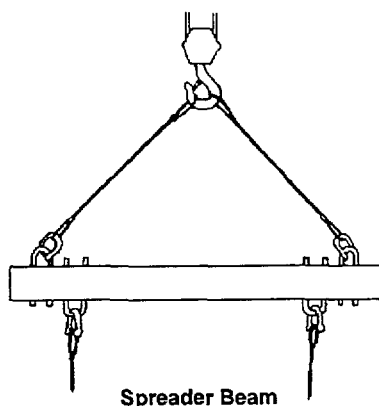

Spreader Beams (12) are used to support long loads during lifts.

They should be used for loads over 12 feet. They eliminate the hazard of the load tipping, sliding or bending as well as the possibility of low sling angles and the tendency of the sling to crush the load.

FREQUENT (PRE-USE) INSPECTION

Spreader Beams shall be inspected at the beginning of each shift for the following deficiencies:

1. Structural deformation, cracks, excessive wear on any part of the lifter.
2. Loose or missing guards, fasteners, covers, stops or name plates.
3. All functional operating mechanisms and automatic hold and release mechanisms for misadjustments interfering with operations.

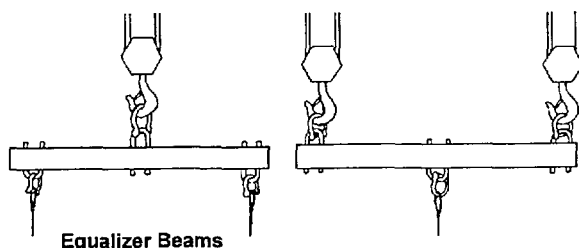

Review Section 14.0 "Structural and Mechanical Lifting Devices" in the DOE H&R Manual.

REVIEW QUESTIONS**SPREADER BEAMS**

1. **The operator/rigger when using a spreader beam, can have it loaded unequally, as a standard practice.**
 - A. True
 - B. False

2. **Side pulls using a spreader beam is an acceptable practice.**
 - A. True
 - B. False

3. **Prior to use the operator should visually inspect the lifting device.**
 - A. True
 - B. False

RIGGING HARDWARE

16

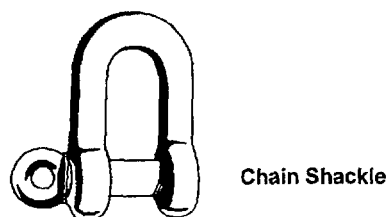
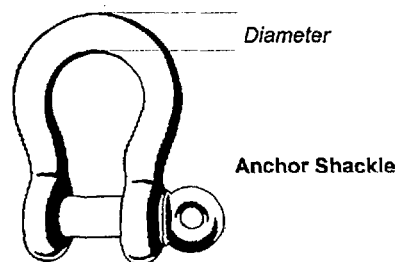

SHACKLES

General Information

Shackles are manufactured in two configurations for use in rigging (16):

- Anchor shackle* -- has a rounded eye which makes it suitable for attaching one or more lifting devices, such as hooks or slings.
- Chain shackle* -- has a straight eye designed for connecting to a single lifting device.

NOTE Both are available with screw pins, round pins, or safety bolts. Screw pins are the type used at WVNS.

Each shackle body shall be permanently and legibly marked in raised or stamped letters on the side of the shackle bow with an identifying manufacturer's name or trademark, shackle size, and its SWL.

Shackle size is determined by the diameter of the bow or body.

FREQUENT (PRE-USE) INSPECTION (17)

- 1) Check pin to see if it seats completely.
- 2) Check to see that pin threads easily by and into and out of the shackle.

17

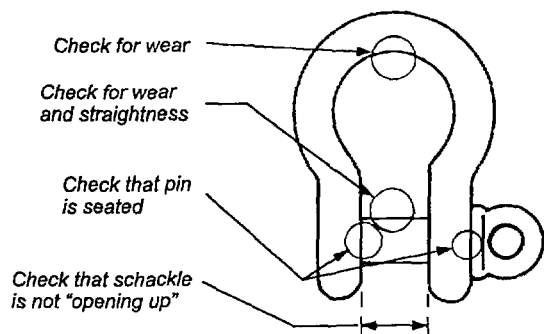

18

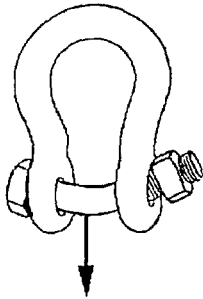

Never replace the shackle pin with a bolt.
The load will bend the bolt.

19

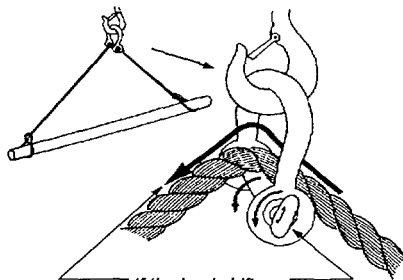

If the load shifts, the sling will unscrew the shackle pin

20

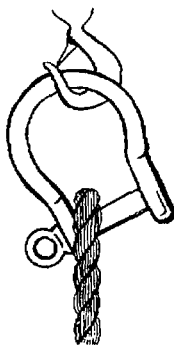

Do not pull shackle at an angle - the legs may open up or cause distortion at maximum loads.

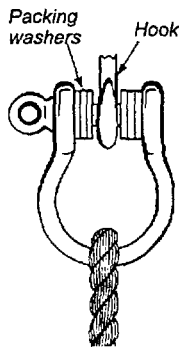

Pack the pin with washers to centralize the shackle.

- 3) The pin shall show no signs of deformation.
- 4) Check for excessive thread exposure when pin is seated completely.
- 5) Check for opening of shackle throat.
- 6) Check for excessive wear, cracks, and corrosion.

Operating Guidelines

- 1) Never replace the shackle pin with a bolt, only a properly fitted pin shall be used. Bolts are not intended to take the bending that is normally applied to the pin (18).
- 2) Shackles shall not be used if the pin cannot be completely seated. The pin need be only hand tight for lifting. Use only shackles with screw pin, round pin with cotter should not be used.
- 3) Screw pin shackles shall not be used if the pin can roll under load and unscrew (19).
- 4) Shackles shall never be allowed to be pulled at an angle (eccentric loading) because the capacity will be tremendously reduced (20).
 - Eccentric loading of the shackle may cause the shackle to open up or distort.
- 5) The shackle pin should go on the hook whenever possible (20).
 - Washers may be used to pack the pin to centralize the shackle if necessary.

21

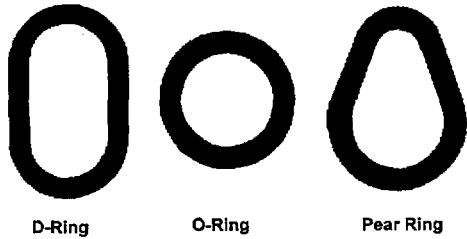

D-Ring

O-Ring

Pear Ring

RINGS

Rings (21) should be **forged steel** and **weldless**. Welded rings are not recommended but may be used if designed by a qualified engineer and subject to NDT testing.

Rings shall be visually inspected for damage, corrosion, wear, cracks, twists, and openings.

EYEBOLTS

There are two types (22):

- Shouldered** - used for *vertical and angular lifts*; when used for angular lifts the Safe Working Load (SWL) is to be down rated as shown in Table 1. Angles less than 45 degrees are prohibited.

Shoulder must be flush with the surface and screw.

- Unshouldered** - for *vertical lifts only*, angular lifts will bend threaded shaft.

22

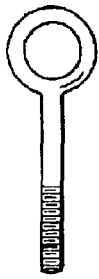

Unshouldered

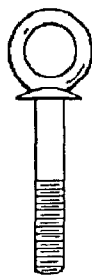

Shouldered

General Requirements

- 1) **Shouldered eyebolts** shall be used for all applications, except where it is not possible due to the configuration of the item. When unshouldered eyebolts are used, nuts, washers and drilled plates shall not be used to make shouldered eyebolts. Swivel eyebolts are also available in the tool crib.

Table 1 Shoulder-Type Eye Bolts

Stock Diameter (Inches)	Safe Working Loads (lbs) Corresponding To Angle of Pull			
	Vertical	75°	60°	45°
1/4	500	Reduce Vertical Loads By 45%	Reduce Vertical Loads By 65%	Reduce Vertical Loads By 75%
5/16	800			
3/8	1,200			
1/2	2,200			
5/8	3,500			
3/4	5,200			
7/8	7,200			
1	10,000			
1-1/4	15,200			
1-1/2	21,400			

NOTE SWL for plain (shoulderless) eye bolts as for shoulder bolts under vertical load. Angular loading is not recommended.

- 2) Eyebolts shall have a minimum thread engagement between the eyebolt and its tapped hole of 1-1/2 times the diameter of thread engagement. Nuts on through-eyebolts shall be self-locking types. The shoulders shall seat uniformly and snugly against the surface on which they bear.

Inspection

- 1) Careful visual inspection of each eyebolt immediately before use is mandatory. Eye bolts that are cracked, bent or have damaged threads shall be discarded.
- 2) The shank of the eye bolt shall not be undercut and shall have a smooth radius into the plane of the shoulder.

Operation Practices

- 1) The size of the hole shall be checked for the proper size of eyebolt prior to installation. The condition of the threads in the hole shall be checked to ensure the eyebolt will secure, and the shoulder can be brought to a snug and uniformly engaged seat.
- 2) When installed, the shoulder of the eyebolt must be flush with the surface. When eyebolts cannot be properly seated and aligned with each other, properly sized washers or shims may be inserted under the shoulder to facilitate the eyebolts being tightened and aligned (23). However, minimum thread engagement must be maintained.

23

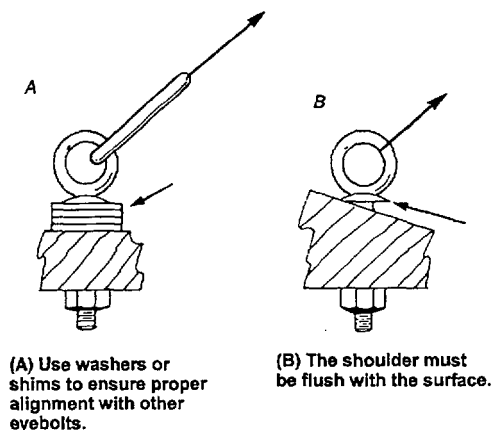

3) Angular loading of eyebolts should be avoided. Angular loading occurs in any lift in which the lifting force is applied at an angle to the centerline of the shank of the eyebolt. Angular loading of the eyebolt less than 45 degrees shall be prohibited. The eyebolt loading shall never exceed the values found in Table 1.

4) When more than one eyebolt is used in conjunction with multiple-leg rigging, it is recommended that spreader bars, lifting yokes, or lifting beams be utilized to eliminate angular loading. When these cannot be used, the values in Table 1 must not be exceeded.

24

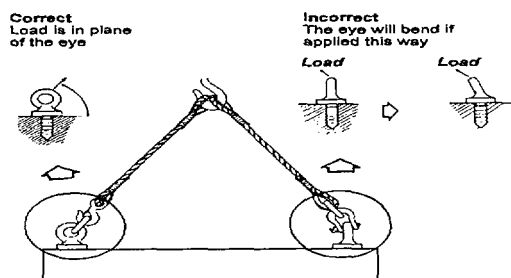

5) To keep bending forces on the eyebolt to a minimum, the load shall always be applied in the plane of the eye, never in the other direction (24).

6) If the hook will not go completely into the eyebolt, a shackle will be used to avoid hoot tip loading.

7) Slings shall not be reeved through the eyebolt or reeved through a pair of eyebolts (25). Only one leg should be attached to each eyebolt. Reeving slings through eyebolts adds greater load tension in the eyebolt than normally calculated by using the sling angle.

25

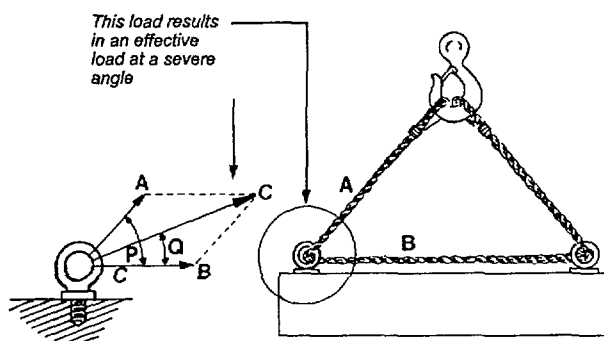

The following example emphasizes the importance of checking your rigging prior to a lift and also stresses the importance of using tag lines and staying clear of the load.

On October 15, 1992, a 22-ton concrete shielding block fell while being transported by crane about 25 feet above the floor of a building at the Los Alamos Accelerator Complex. The block bounced about 20 feet laterally from the point of impact and crashed into detector instrumentation causing more than \$100,000 in damage. While the block was being moved, one of the eyebolts pulled out of its insert and the entire load shifted to the remaining eyebolt, which supported the block briefly before it also failed, allowing the block to fall, striking other shield blocks below. Facility personnel determined that, because the eyebolts were of unequal length, the shorter eyebolt was backed out (unthreaded) to allow both bolts to extend to an equal height above the block surface. The resulting thread engagement of the shorter bolt was insufficient and led to it pulling free of its insert. There were no injuries to personnel because the area below the crane lift path was evacuated prior to lifting and transporting the block.

26

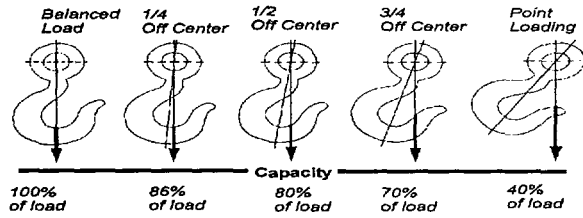

27

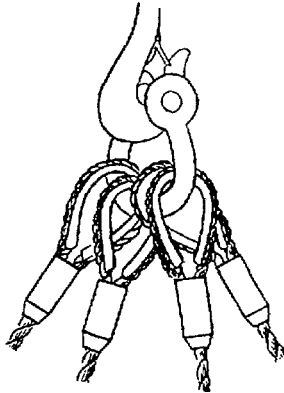

28



The safety latch helps prevent release of the load.

HOOKS

- 1) The safe working load (SWL) for a rigging hook shall be equal to or exceed the rated load of the chain wire rope, or other suspension member to which it is attached (26). The designed SWL applies only when the load is applied in the saddle of the hook.
- 2) It is a good practice to use a shackle when two or more sling eyes are used on a hook (27). This allows the load to be centralized on the hook for full capacity. Never tip load a hook.
- 3) The manufacturer's identification shall be forged or die-stamped on a low-stress and nonwearing area of the hook.
- 4) The load hook should be the weakest member of the lifting equipment, so it will bend if overloaded before any other piece of equipment fails.
- 5) Hooks shall be provided with a safety latch to bridge the throat opening to prevent the release of load lines (28). Remote "in cell" cranes may not have a safety latch, or other applications that make the latch impractical.
- 6) Hook tips should point out and away from the load to assure when slack is taken up the hook will not tip load (29).

Hands, fingers, and body shall be kept from between the hook and load.

29

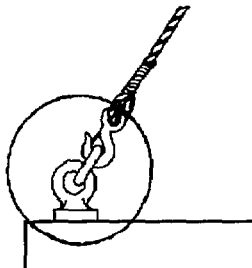

Hook tips should point out and away from the load

30 Inspection

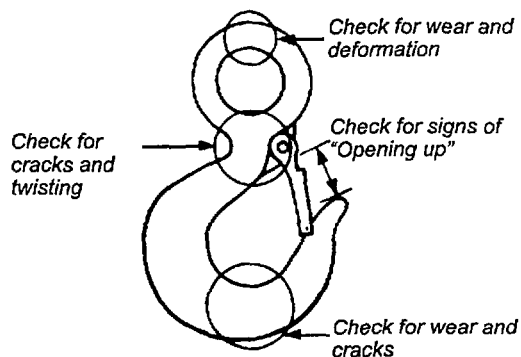

FREQUENT (PRE-USE) INSPECTION (30)

- 1) Look for distortions such as bending, or twisting exceeding 10 degrees from the plane of the unbent hook.
- 2) Check for an increase in throat opening exceeding 15% of original throat opening. On most hooks there will be punch marks as reference points to be by.
- 3) Check for wear in the saddle area of the hook. Wear exceeding 10% of the original dimension is sufficient enough to take the hook out of service.
- 4) Check for cracks, severe nicks, and gouges. Transverse cracks are more critical to a hook's performance than longitudinal cracks.
- 5) Check the hook attachment and securing means for defects.
- 6) Rigging hooks shall be inspected as a part of the slings to which they are attached.

WIRE ROPE CLIPS

General Information

- 1) They are used in the field to make an eye on wire rope. Will be only 80 percent of the wire rope's strength. They shall not be used to fabricate wire rope slings except where the application of slings prevents the use of prefabricated slings, and must be proof tested to 200 percent of safe working load.

31

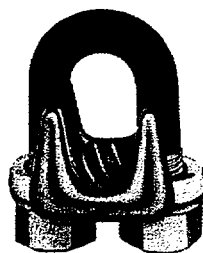

U-Bolt Clip

2) Clips (clamps) shall be legibly and permanently marked with size and the manufacturer's identifying mark.

3) Clips should not be reused as they may not torque properly on the second application.

FREQUENT (PRE-USE) INSPECTION

Before use, clips shall be visually inspected for damage, corrosion, wear, and cracks. Verify that the clip components are marked as stated under "general information." Clips shall be inspected to ensure that the assembled clip contains the same size, type, and class parts.

Different types of clips are as follows:

- 1) *U-Bolt clip* (31)
- 2) *Fist grip clip* (32)
- 3) *Collet connection clip* (33)

32



Fist Grip Clip

33

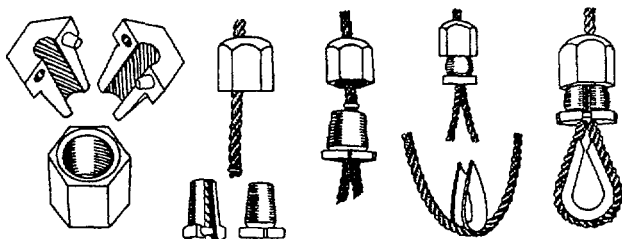

Collect Connection Clip

34

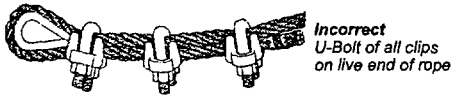
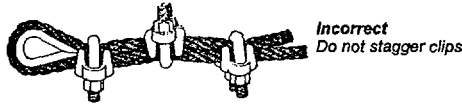
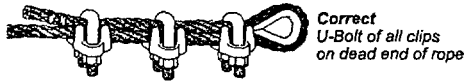

Operation Practices

- 1) Assure clips are orientated correctly (34)
- 2) When using single grip clips, be sure to put the saddle on the live end of the rope.
- 3) Be sure to torque clips to proper specification. (See Tables 2 & 3)
- 4) Check torque after use and retorque after use if necessary.
- 5) Follow the proper procedure when installing clips (35).

- Apply first clip one base width from dead end of wire rope. Tighten nuts evenly to recommended torque.
- Apply second clip nearest the loop. Turn evenly but **do not tighten**.
- Apply all other clips spaced equally in between the first two. Apply tension and tighten all nuts to recommended torque.
- Recheck torque after use.

Table 2 Clip Installation (Example)

Double Saddle Clips

Rope Diameter (inches)	Minimum Number of Clips	Amount of Rope to Turn back (inches)	Torque in Foot-Pounds Unlubricated Bolts
3/16	2	4	30
1/4	2	4	30
5/16	2	5	30
3/8	2	5 1/2	45
7/16	2	6 1/2	65
1/2	3	11	65
9/16	3	12 3/4	130
5/8	3	12 1/2	225
3/4	3	16	225
7/8	4	26	225
1	5	37	360
1 1/8	5	41	360
1 1/4	6	55	500
1 3/8	6	62	
1 1/2	6	66	

Table 3 Installation of Wire Rope Clips

Rope Diameter (inches)	Minimum Number of Clips	Rope Turn Back From Thimble (inches)	Torque in Foot-Pounds Unlubricated Bolts
1/8	2	3 1/4	-
3/16	2	3 3/4	-
1/4	2	4 3/4	15
5/16	2	5 1/2	30
3/8	2	6 1/2	45
7/16	2	7	65
1/2	3	11 1/2	65
9/16	3	12	95
5/8	3	12	95
3/4	4	18	130
7/8	4	19	225
1	5	26	225
1 1/8	6	34	225
1 1/4	6	37	360
1 3/8	7	44	360
1 1/2	7	48	360
1 5/8	7	51	430
1 3/4	7	53	590
2	8	71	750
2 1/4	8	73	750
2 1/2	9	84	750
2 3/4	10	100	750
3	10	106	1200

35 Method of Installing Wire Rope Clips

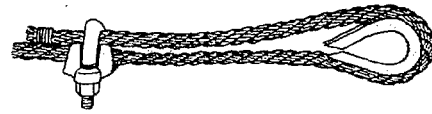

Apply first clip - one base width from dead end of wire rope - U-Bolt over dead end. Tighten nuts evenly to recommended torque.

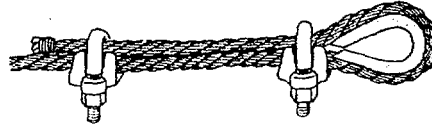

Apply second clip - nearest loop as possible - U-Bolt over dead end. Turn on nuts firm but do not tighten.

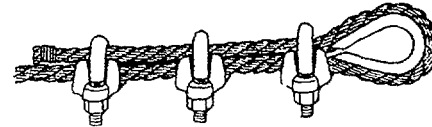

All other clips - space equally between first two.

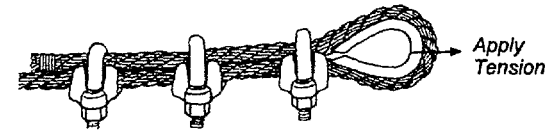

Apply tension and tighten all nuts to recommended torque.

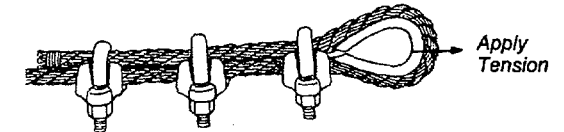

Recheck nu torque after rope has been in operation.

Turnbuckle End Fittings

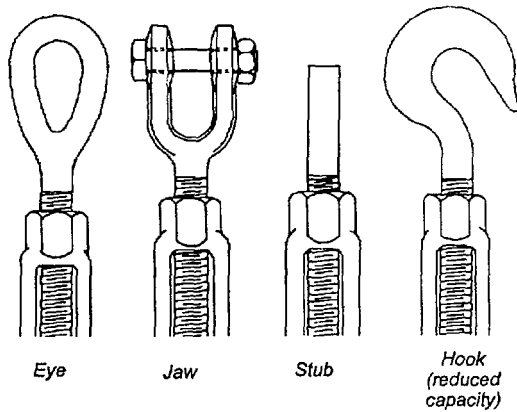

37

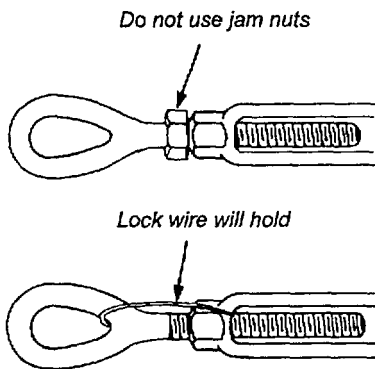

38

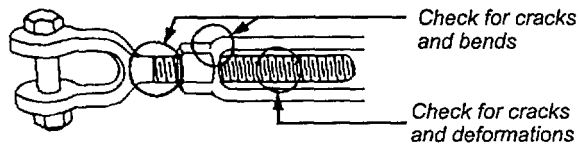

TURNBUCKLES

General Information

- 1) Turnbuckles should be avoided; however if they are used in a rigging system, that system must be designed, analyzed, and approved by a qualified engineer.
- 2) Turnbuckles used in hoisting and rigging operations shall be fabricated from forged alloy steel.
- 3) If a turnbuckle is used in an application where vibration is present, the end fittings should be secured to the frame with lock pins or wires to prevent them from turning and loosening. Locknuts (jam nuts) shall not be used. Locknuts can significantly increase the stresses imposed upon the threads (37).
- 4) Before placing turnbuckles in lifting service, a permanent identification tag shall be affixed.

Table 4 Turnbuckles (Example)

Weldless Construction
Forged Alloy Steel

End Fitting Stock Diameter (inches) Fitting (lbs)	SWL of any Jaw End Fitting, Eye End Fitting, and Stub End Fitting (lbs)	SWL of any Turnbuckle having a Hook end
1/4	500	400
5/16	800	700
3/8	1,200	1,000
1/2	2,200	1,500
5/8	3,500	2,250
3/4	5,200	3,000
7/8	7,200	4,000
1	10,000	5,000
1 1/4	15,200	7,500
1 1/2	21,400	-
1 3/4	28,000	-
2	37,000	-
2 1/2	60,000	-

Inspection

Turnbuckles shall be inspected for damage before each use (38). Inspect turnbuckles for the following:

- 1) Cracks and bends in the frame.
- 2) Thread damage and bent rods.
 - Damaged threads or bent frame members shall disqualify the unit for use.

NOTE Turnbuckles not in lift service do not have to meet testing criteria.

Review in Section 12.0 of the DOE H&R Manual, Subsection 12.5, "Turnbuckles."

LOAD-MEASURING DEVICES

Requirements for Their Use

- 1) Load-indicating devices shall be used with lifts where the binding or friction of the load could result in a greater stress in the hoist or tackle than would result from the apparent hook load.
- 2) The use of load-indicating devices shall be specified for loads which could be over 90% of the rated capacity of the equipment being used, if the load cannot be weighed and verified before the lift.
- 3) Load-indicating devices are not required in the course of routine operations where loads of known and essentially consistent weight are to be handled or if the equipment includes a functional load limiter.

39

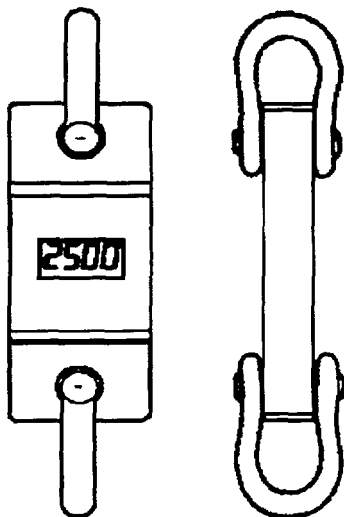

The load measuring device is used to measure loads under stress

Identification Requirements

Labels shall be conspicuously placed on the indicating system readout, at the operator's location, or both, giving the following:

- 1) Units of measure.
- 2) Maximum capacity of the indicating system.
- 3) Operating range of the indicating system for which the accuracy criteria are met.
- 4) Basic operating instructions and precautions, including the recommended interval for performance testing.
- 5) Device manufacturer's name, address, and device model number.
- 6) Date when calibration expires.

Operation of Load-Measuring Devices

Operation and maintenance of the load-indicating device shall be in accordance with the appropriate manufacturer's recommendations to attain system accuracy. Manuals containing installation, operation, test, and service information shall be provided by the manufacturer, and a copy shall be available to the operator and/or other responsible person at all times.

Range

The Load-indicating system should be selected to ensure the expected load is between 10% to 70% of full scale indication.

Example: You would not select a dynamometer with 2000 lbs. Capacity to pick a 1700 lb load. (1700 lbs. Is 85% of the dyno's capacity)

Operation Checks

The load-indicating system shall include a means for the operator or another responsible person to determine that it is operative before crane use. And the readout device shall be located so the operator, and/or other signal person, can obtain readings from the normal working position.

Review in Section 12.0 of the DOE H&R Manual, Subsection, 12.8, "Load-Indicating Devices."

REVIEW QUESTIONS**RIGGING HARDWARE**

- 1. The size of the shackle is determined by the diameter of the _____.**
 - A. Body
 - B. Bolt
 - C. Pin
 - D. Opening

- 2. The shackle pin should go on the crane hook whenever possible.**
 - A. True
 - B. False

- 3. The shackle shall not be used if the pin cannot be completely seated with hand pressure.**
 - A. True
 - B. False

- 4. Shouldered eyebolts can be used with angles to 45 degrees with a decrease in its capacity.**
 - A. True
 - B. False

- 5. Unshouldered eyebolts can be used for vertical and angular lifts.**
 - A. True
 - B. False

- 6. Eyebolts should have a minimum thread engagement between the eyebolt and its tapped hole of 1-1/2 times the diameter of the thread.**
 - A. True
 - B. False

7. **Eyebolts should be pulled or loaded in the plane of the eye.**
- A. True
 - B. False
8. **To prevent tip loading, when using a sling with a hook attachment, the hook tip should point out and away from the load.**
- A. True
 - B. False
9. **To carry the rated load of a hook, the load should sit in the saddle of the hook.**
- A. True
 - B. False
10. **It's a good practice to use a shackle when two or more sling eyes are used on a hook to center the load on the hook.**
- A. True
 - B. False
11. **Wire rope clips must have the U-bolt section on the dead or short end of the rope.**
- A. True
 - B. False
12. **Wire rope clips will develop approximately 80 percent of the rope strength.**
- A. True
 - B. False
13. **Wire rope clips can be reused numerous times.**
- A. True
 - B. False
14. **When Turnbuckles are used, they are designed as part of the rigging system.**
- A. True
 - B. False
15. **Load indicating devices should be used for which of the following:**
- A. Routine operations
 - B. Where binding or friction can occur
 - C. Loads which cannot be weighted
 - D. Both B and C

INSPECTION TAG

INSPECTION TAG

Rigging hardware should be used to lift items only within its lifting capacity. The **Inspection Tag** is a permanent tag attached to slings, hooks, and below the hook lifting devices. It indicates the *safe working load (SWL)*, *inspection date* and *serial number*. It should be inspected prior to using the item to assure it is within compliance. The process is outlined in SOP 15-29, "Inspection of Non-Mechanized Rigging Components."

Inspection Tags:

Bridle Sling

Description _____ WVNS S/N _____ SWL _____ Inspection Date _____ Expiration Date _____	<table style="width: 100%; border-collapse: collapse;"> <tr> <td style="border: none; width: 10%;"></td> <td style="border: none; width: 10%;"></td> <td style="border: none; width: 10%;"></td> <td style="border: none; width: 10%;"></td> <td style="border: none; width: 10%;"></td> <td style="border: none; width: 10%;"></td> <td style="border: none; width: 10%;"></td> <td style="border: none; width: 10%;"></td> </tr> <tr> <td style="border: none; text-align: center;">15°</td> <td style="border: none; text-align: center;">30°</td> <td style="border: none; text-align: center;">45°</td> <td style="border: none; text-align: center;">60°</td> <td style="border: none; text-align: center;">MFG</td> <td style="border: none;"></td> <td style="border: none;"></td> <td style="border: none;"></td> </tr> </table>									15°	30°	45°	60°	MFG			
15°	30°	45°	60°	MFG													

Regular Straight Sling

Description _____ WVNS S/N _____ SWL _____ Inspection Date _____ Expiration Date _____	<table style="width: 100%; border-collapse: collapse;"> <tr> <td style="border: none; width: 10%;"></td> <td style="border: none; width: 10%;"></td> <td style="border: none; width: 10%;"></td> <td style="border: none; width: 10%;"></td> <td style="border: none; width: 10%;"></td> <td style="border: none; width: 10%;"></td> <td style="border: none; width: 10%;"></td> <td style="border: none; width: 10%;"></td> </tr> <tr> <td style="border: none; text-align: center;">Vert: SWL</td> <td style="border: none; text-align: center;">Choker: SWL</td> <td style="border: none; text-align: center;">Basket: SWL</td> <td style="border: none; text-align: center;">MFG</td> <td style="border: none;"></td> <td style="border: none;"></td> <td style="border: none;"></td> <td style="border: none;"></td> </tr> </table>									Vert: SWL	Choker: SWL	Basket: SWL	MFG				
Vert: SWL	Choker: SWL	Basket: SWL	MFG														

CRITICAL LIFTS

GENERAL

This section specifies the guidelines for critical lift determination and delineates the requirements applicable to planning and performing a critical lift in a safe and judicious manner as is outlined in Section 2 of the DOE H&R manual.

Critical Lift Determination

An appointed person shall classify each lift into one of the DOE categories (ordinary and critical) prior to planning the lift.

A lift shall be designated as a critical lift if collision, upset, or dropping could result in any one of the following:

- a. Damage that would result in unacceptable delay to schedule or other significant program impact, i.e., loss of vital data.
- b. Significant release of radioactive/other hazardous material or other undesirable conditions.
- c. Unacceptable risk of personnel injury or significant adverse health impact (on-site or off-site).
- d. Undetectable damage that would jeopardize future operations or the safety of a facility.

NOTE *A lift should also be designated as critical if the load requires exceptional care in handling because of size, weight, close-tolerance installation, high susceptibility to damage, or other unusual factors.*

Critical Lift Requirements

The operating organization shall appoint a person-in-charge (PIC) of the entire lifting operation. This person shall meet the definitions of appointed, designated, and qualified, as set forth in Section 6.0 of the DOE Hoisting and Rigging Manual and shall be present at the lift site during the entire lifting operation.

The PIC shall ensure that a pre-job plan or procedure is prepared which defines the operation and shall include the following:

- a. Identification of the item(s) to be moved, the weight, dimensions, center of gravity, and the presence of hazardous or toxic materials.
- b. Identification of operating equipment [crane(s)], to be used by type and rated capacity.
- c. Rigging sketches which shall include, as applicable:
 - Identification and rated capacity of sling, lifting bars, rigging accessories, and below-the-hook lifting devices
 - Load-indicating devices
 - Load vectors
 - Lifting points

- Sling angels
 - Boom and swing angles
 - Method of attachment
 - Crane orientations
 - Other factors affecting equipment capacity.
- d. Operating procedures including special instructions to operators including rigging precautions and safety measures to be followed as applicable.

Experienced operators who have been trained and qualified to operate the specific equipment to be used shall be assigned to make the lift.

Only designated, qualified signalers shall give signals to the operator. However, the operator shall obey a STOP signal at all times, no matter who gives the signal.

The procedure and rigging sketches shall be reviewed and approved by the responsible manager or designee and the responsible oversight organization, i.e., Safety, QA/QC, prior to making the lift.

A prelift meeting involving participating personnel shall be conducted prior to making a critical lift. The critical lift plan/procedure shall be reviewed and questions shall be resolved.

REVIEW QUESTIONS

Critical Lifts

- 1. List the four factors which would classify a lift as critical.**

- 2. A person-in-charge (PIC) is required for a critical lift.**

- A. True
B. False

- 3. List three main items the person-in-charge is required to do for critical lifts.**

GENERAL HOISTING AND RIGGING PRACTICES

Guidelines are outlined in SOP 00-38, "Administration of Hoisting and Rigging Activities." This procedure outlines the procedural steps for the execution and control of hoisting and rigging activities at the WVDP. Review this document for the requirements of work documents, pre-job briefing, and inspection and load tests.

Operator Rules

- 1) The operator shall be familiar with the crane or hoist operating characteristics and be aware of the safety rules for operators.
- 2) For mobile cranes barricade accessible areas within the swing radius of the rear of the rotating superstructure of the crane to prevent anyone from being struck or crushed by the crane.
- 3) No crane, hoist, or rigging hardware shall be loaded beyond the rated capacity, except for test purposes.
- 4) For critical lifts, the PIC is responsible for verifying that the total load is accurately determined before the lift and will not exceed the equipment's rated capacity.

- 5) Hoisting and rigging for ordinary lifts that require more than one person, i.e., an operator and a rigger(s), shall have a designated leader. The designated leader *shall be present* at the lift site for the entire lift operation.
 - a) Hoisting and rigging operations for ordinary lifts require a designated leader who shall be present at the lift site during the entire lifting operation. If the lift is being made by only one person, that person assumes all responsibilities of the designated leader.
 - b) Leadership designation may be by written instructions, specific verbal instructions for the particular job, or clearly defined responsibilities within the crew's organizational structure.
 - c) The designated leader's responsibility shall include the following:
 1. Ensure that personnel involved understand how the lift is to be made.
 2. Ensure that the weight of the load is determined, that proper equipment and accessories are selected, and that rated capacity is not exceeded.
 3. Survey the lift site for hazardous/unsafe conditions.
4. Ensure that equipment is properly set up and positioned.
5. Ensure that a signaler is assigned, if required, and is identified to the operator.
6. Direct the lifting operation to ensure that the job is done safely and efficiently.
7. Stop the job when any potentially unsafe condition is recognized.
8. Direct operations is an accident or injury occurs.
- d) The operator, or a designated person, shall ensure that the crane is still within the inspection interval.
- e) The operator, or a designated person, shall visually examine the crane.

See Section 7.0 of the DOE H&R Manual.

Moving the Load

- 1) The signal person directing the lift (or if a signal person is not used, the operator) shall ensure the following:
 - The load is well secured and balanced in the sling or lifting device before it is lifted more than a few inches.
 - That the load path is clear of obstructions.

- 2) Before starting to lift, the operator will ensure the following conditions are met:
 - Hoist rope or chain is not kinked.
 - Multiple-part lines are not twisted around each other.
 - If the load line (rope or chain) is slack, ensure that the line seats on the sheaves, sprockets, etc., as the slack is removed.
 - See that the load line is plumb to prevent side pull. Two degrees out of plumb is considered excessive. It introduces stresses in the crane that were not necessarily accounted for in the design of the crane or hoist. It may result in bridge or trolley brakes holding the load. Or can possibly cause damage to the rope as it runs up the side of the sheave or drum. The load center of gravity should have the hook above it.

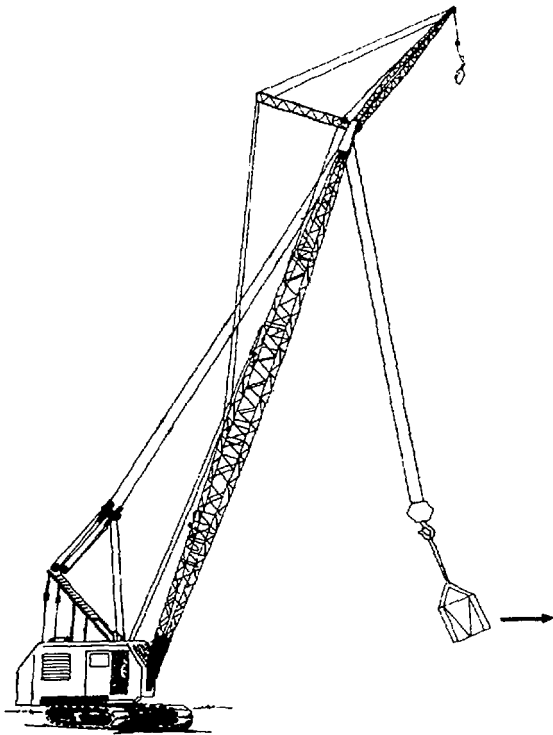

Keep the load under control
at all times

- 3) Ensure that the load or hook is not allowed to swing during crane travel or hoist operation (40). For outdoor equipment, wind speed must be considered. Wind speeds in excess of 25 mph should be evaluated by a qualified person to determine if the size, shape and weight of the load can be safely lifted.

- 4) During power hoisting, engage the load in a controlled, deliberate manner and ensure there is no sudden acceleration or deceleration of the load (quick reversals in direction should be avoided). Sudden acceleration or deceleration, and quick reversals in direction creates a shock loading situation, which should at all times be avoided. A shock load can very easily cause the load to double the load tension on the crane, hoist, and rigging equipment.
- 5) During initial load application, lift the load only a few inches at which time brake function, load balance and sling/rigging hardware integrity can be checked. There shall be no downward drift of the load during this stop.
- 6) Do not carry loads over people.
- 7) All personnel including the rigger shall stay clear of the load. Use a tag line to help control the load.
- 8) Never rise the load higher than necessary.

TAG LINES

The *safest* method for a rigger to control a load suspended from a hook is with a tagline or a restraining device. A tagline will give the rigger the distance he need if the load shifts or moves unexpectedly.

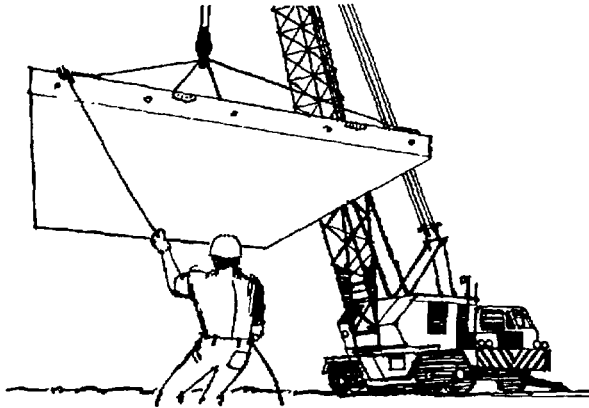

Tag lines help to control unexpected shifts or movement of loads.

When moving or placing machinery, it is advisable for all crew members to stay out of the path of the load as it is being maneuvered into position. Unfortunately, many "pinch and crush" injuries occur every year because some people believe they can grab onto and force a 6,500 lb. load to stop swinging before it can naturally "settle-down."

WVNS has the following guidelines:

Once the load is within its final placement it may be adjusted by hand. **WARNING:** Regardless of height or location above a final resting position, if there is a risk that loss of control of the load could result in the load striking or pinching the worker, then workers must not place hands on loads or otherwise work in close proximity to a suspended load. The rigging arrangement

and the shape or size of the load must be carefully evaluated when determining the possible swing/fall area of the load. Conservative judgement is required. Do not perform work on a suspended load or place any body part under a load.

Place the tagline(s) at points on the load for control during lift-off, traveling and placement. The tagline person should never loop the line around his arm or body. He should have a clear view of his travel path and the signaler so he can anticipate the load's movement. The tagline person will have his best control of the load if he is trailing the load while traveling with it.

A 180 lb. man vs. a crane and load is no reasonable match-up. The tagline person should provide whatever control he can. He should also be aware of his abilities and limitations.

ELECTRICAL POWER LINES

The most repeated killer of riggers is electrocution caused by the contact of the boom, load line or load of a crane with electrical power lines. When working around any powerline, ensure a signal person is stationed to warn the operator when any part is approaching the minimum safe distance of 10-50 feet, depending on the line voltage.

41

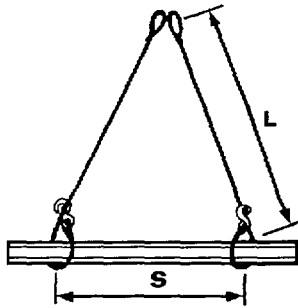

Be sure to check sling angle

Sling and Wire Rope Efficiencies

Slings require special attention because seemingly insignificant changes in sling angle drastically affect the loading (41).

When using slings, exercise extreme caution because you are going to be developing unknown loads, under less than ideal circumstances, with less than perfect equipment.

Failure to provide blocking or protective pads will permit sharp corners to cut slings. Pulling slings from under loads will result in abrasion and kinking. Dropping loads on slings or running equipment over them will cause crushing. Sudden starts and stops when lifting loads will increase the stresses in them, also improper storage will result in deterioration.

Because of severe service expected of slings, errors in determining load weights, the effect of sling angle on the loading, and the loss of efficiency due to D/d ratios, it is mandatory that all safe working loads be based on a factor of safety of at least 5:1.

When we speak of a wire rope efficiency, what we are talking about is the ratio between its actual strength in a given situation, and its rated breaking strength. Two areas where efficiency is commonly discussed are end fitting efficiency, and D/d ratios.

42 End Fitting Efficiencies

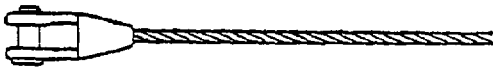

1) Speltered and Resin socket end fittings...100%

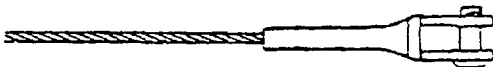

2) Swaged socket end fitting...100%

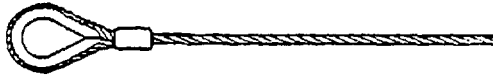

3) Swaged sleeve end fitting...95%



4) Hand tucks: 1/4" ...90%; 3/8" ...88%; 1/2" ...86%
5/8" ...84%; 3/4" ...82%; 7/8" ...80%

Hitch Types

Every Lift Uses 1 of 3 Basic Hitches

Straight, or vertical, attachment is simply using a sling to connect a lifting hook to a load. Full rated lifting capacity of the sling may be utilized, but must not be exceeded. Whenever a single sling is used in this manner, a tagline should be used to prevent load rotation which may cause damage to the sling.

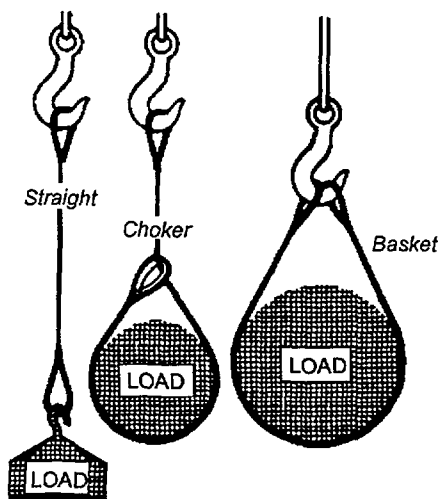

Good and Bad Rigging Practices

Use of Chokers



Good - No cutting action on running lines



Bad - Because of cutting action of eye splices on running line.

Suspending Needle Beams of Scaffolds

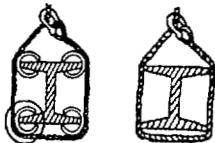

Good - Sharp corners padded.

Bad - Steel can cut rope.

Hook Slings

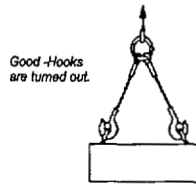

Good - Hooks are turned out.

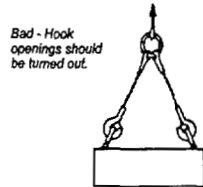

Bad - Hook openings should be turned out.

Double slings shall be used when hoisting 2 or more pieces of material over 12 ft long.

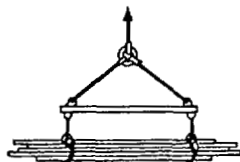

Right - Load over 12 ft long

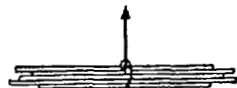

Wrong - Load over 12 ft long

When two or more slings are attached to the same lifting hook in straight, or vertical, manner, the total hitch becomes, in effect, a lifting bridle, and the load is distributed among the individual slings.

CHOKER hitches reduce lifting capability of a sling, since this method of rigging affects ability of the wire rope components to adjust during the lift. A choker is used when the load will not be seriously damaged by the sling body—or the sling damaged by the load, and when the lift requires the sling to snug up against the load.

The diameter of the bend where the sling contacts the load should keep the point of choke against the sling **body** – never against a splice or the base of the eye. When a choke is used at an angle of less than 135 degrees, the sling rated capacity must be adjusted downward to compensate for further loss of capability.

A choker hitch should be pulled tight before a lift is made – *not pulled down during the lift*. It is also dangerous to use only one choker hitch to lift a load which might shift or slide out of the choke.

BASKET hitches distribute a load equally between the two legs of a sling—within below. Capacity of a sling used in a basket is affected by the bend, or curvature, where the sling body comes in contact with the load—just as any wire rope is affected and limited by bending action, as over a sheave.

44

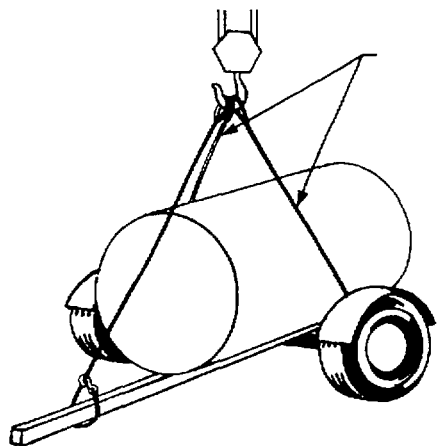

Know what the load in each sling leg will be before the lift is made.

Bridle Hitches

Two, three or four single hitches can be used together to form a bridle hitch for hoisting an object that has the necessary lifting lugs or attachments. They can be used with as many different types of end fittings. They provide excellent load stability when the load is distributed equally among the legs, when the hook is directly over the center of gravity of the load and the load is raised level. In order to distribute the load equally, it may be necessary to adjust the leg lengths with turnbuckles or chain lever hoists. The use of a bridle sling requires that the sling angles be carefully determined to ensure that the individual legs are not overloaded.

Determination of Capacity of 2-Leg Bridle Hitch

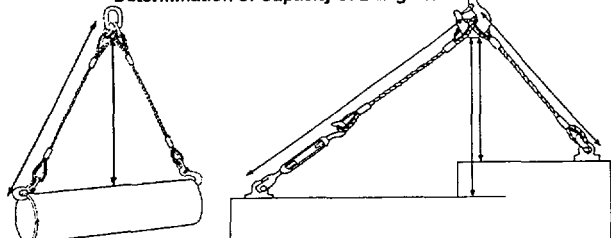

When sling legs are not of equal length use smallest H/L Ratio.

Unless the load is flexible, it is wrong to assume that a 3- or 4-leg hitch will safely lift a load equal to the safe load on one leg multiplied by the number of legs because there is no way of knowing that each leg is carrying its share of the load. With slings having more than 2 legs and a rigid load, it is possible for two of the legs to take practically the full load while the others only balance it (44).

Estimating Load Weights

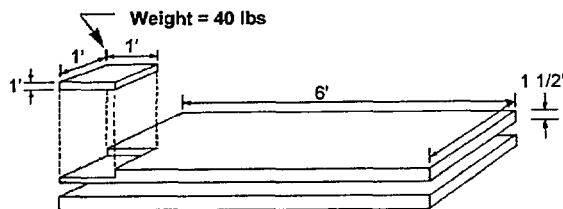

The most important step in any rigging operation is the determination of the weight of the load to be hoisted. If this information cannot be obtained from shipping papers, design plans catalogue data or from other dependable sources, it may be necessary to calculate the weight.

46 Sling Configuration

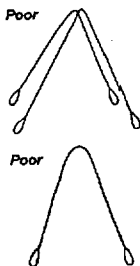
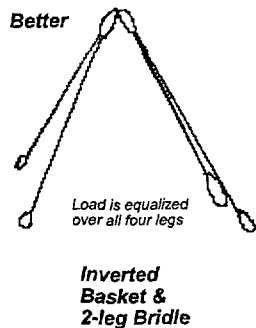
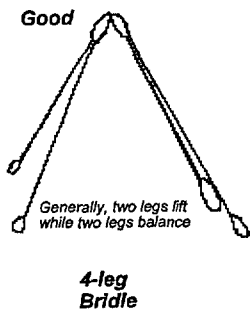
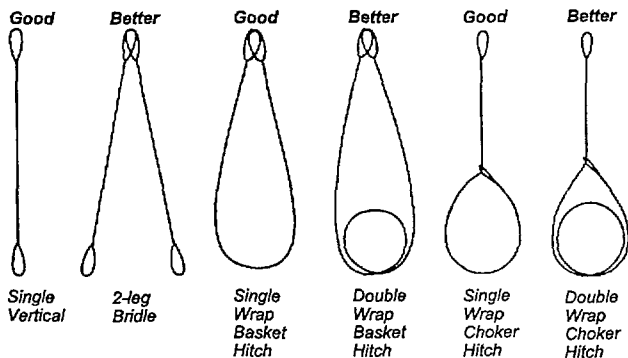

Two Inverted Baskets

Nothing to prevent load tipping. Sling burns across hoist hook.

Weights per Square Feet

The formula to figure square feet is *length x width*.

The basic weight is that of 1 square foot of steel an inch thick is approximately 40 lbs. For example, the weight of two plates of steel measuring 1-1/2" x 3' x 6' would weigh: 2 x 3 x 6 x 60 = 2160 (see above).

- 2 = number of sheets
- 3 = width
- 6 = length
- 60 = number of pounds per 1 square foot of 1 1/2" steel

The weights of angles also can be approximated close enough for safe job use. This is done (in your mind) by flattening out the angle to make it a plate (45). Weights of any structural shape can be computed in this manner by separating the parts and flattening them into rectangles which, in turn, become parts or multiples of a square foot of steel an inch thick.

45



Sling Configurations

On any given day a load can be rigged and moved in a variety of ways. At left are a group of hitch and bridle types which represent good, poor, and unacceptable rigging methods (46).

You must also be concerned with the radius of contact of the sling when it is rigged around the corner of an object. The radius of contact should equal one rope lay giving approximately 80% efficiency. Softeners are often used to create a better ratio.

Sling Configurations

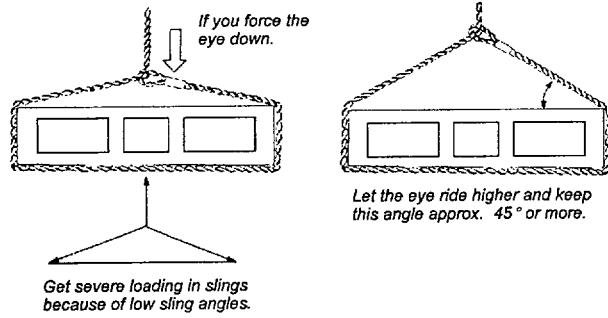

Chain Mesh Slings

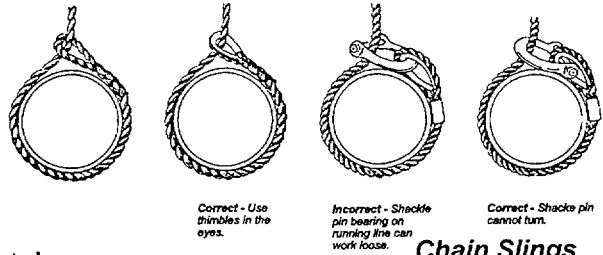
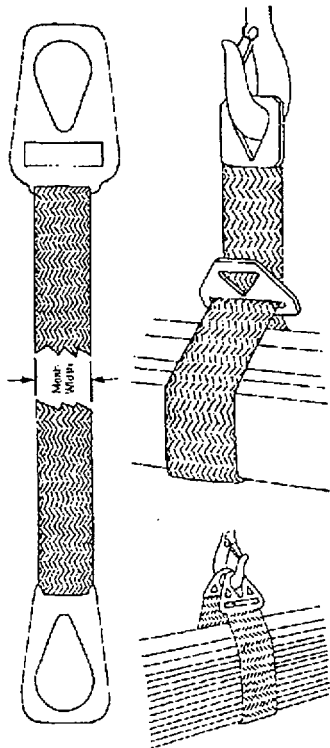

Chain Slings

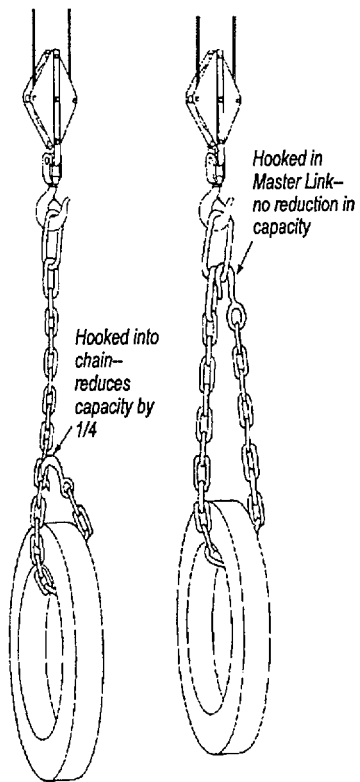

Effect of Low Sling Angle on Webbing

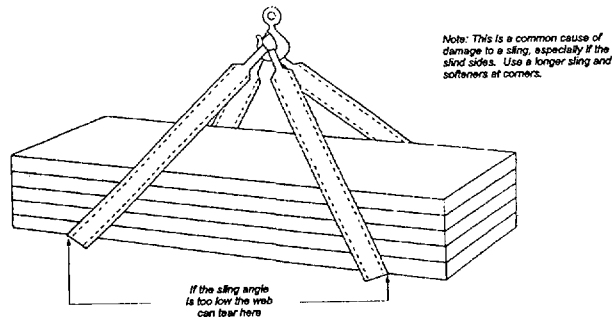

Determination of Capacity of Single Choker Hitch

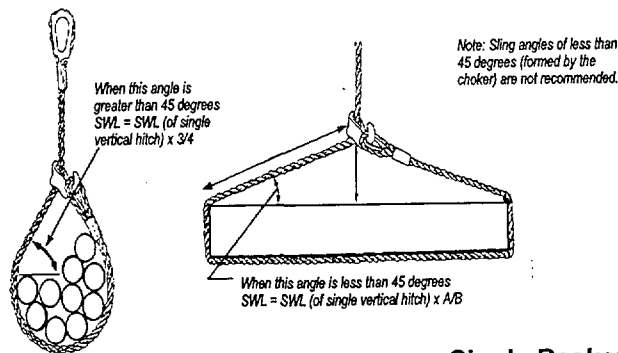

Single Basket Hitch

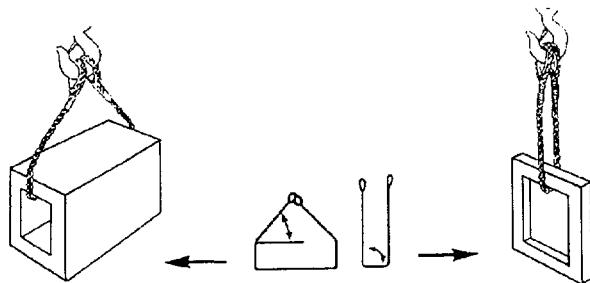

Single Basket Hitch

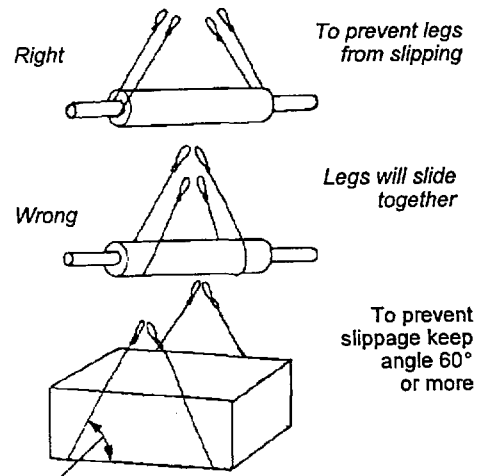

47

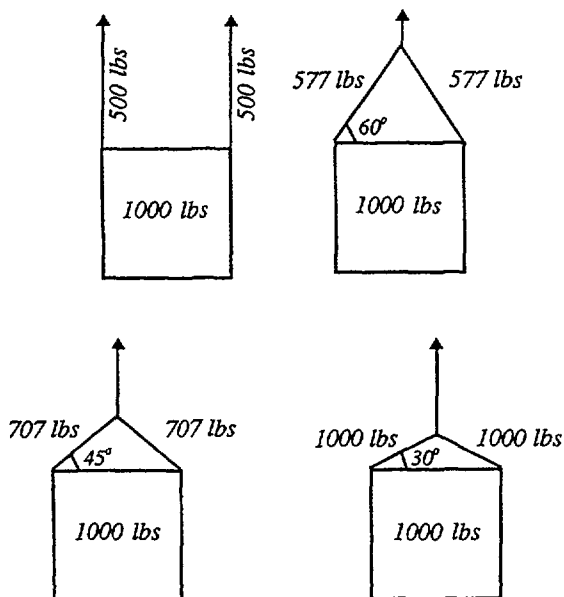

Load Angle Factor (LAF) and Sling Tension

The sling angle formed on the horizontal plane by a sling leg has a definite effect on the rated capacity of the sling. As the angle decreases from the vertical, the amount of lifting capacity decreases. The tension in each leg increases without an increase in the load lifted. A lot of misunderstanding results from the change in carrying capacity of a sling when the leg angle is changed. Actually, there is no change in the tensile strength of the sling leg.

Load Angle Factors (LAF)

A load of 1,000 lbs. Shared by two slings can result in significantly higher forces in the individual sling legs than 500 lbs (47).

Load angle factors are used in determining the load carried by slings at an angle. The steps to determine the LAF and sling tension are as follows:

Step 1: Determine load designated to pick point.

Step 2: Measure the sling length.

Determination of Capacity of 3-Leg Bridle Hitch

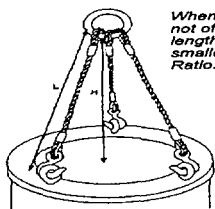

When legs are not of equal length use smallest H/L Ratio.

Note: Load may be supported on only 2 legs while 3rd leg balances it. Therefore, the recommended SWL is: $SWL = SWL \text{ (of single vertical hitch)} \times H/L \times 2$.

Determination of Capacity of 4-Leg Bridle Hitch

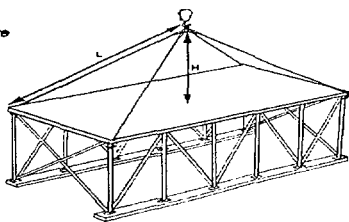

Note: Load may be carried by only 2 legs while other legs only balance it. Therefore, the recommended SWL is: $SWL = SWL \text{ (of single vertical hitch)} \times H/L \times 2$.

Step 3: Measure the vertical height from the horizontal plane of the load to the point where the sling attaches to the suspended hook.

Step 4: Divide the sling length by the vertical height. The result is the "Load Angle Factor" (LAF).

Step 5: Multiply the LAF times the portion of the weight designated to that particular pick point. The result is the total stress load applied to that particular sling.

Review in Section 11.0 of the DOE H&R Manual the examples of load angles.

REAL WORLD EXERCISE

You are tasked with rigging a 10,000 pound air conditioning unit, 10' wide by 12' long by 5' high, using an ordinary lift work document, so that it can be moved from the ground on to the roof of a building at WVNS. The crane is rated at 10 tons, and has passed a daily inspection.

1. Assume the air conditioning unit has a manufacturer's eyebolt in the center of the unit. You decide to hang one shackle from the crane hook, and attach the other to the eyebolt, using a wire-rope sling with a mechanical splice and an independent wire-rope core to perform a vertical lift. The shackles are each rated at 10 tons. What is the minimum diameter of wire-rope sling needed to safely perform the lift?
 - A. 1/4"
 - B. 1"
 - C. 7/16"
 - D. 7/8"
2. You go to the tool crib to pick up the wire-rope sling, and they do not have the diameter of wire-rope sling that you need. The tool crib does have a nylon double ply web sling that can support 9,000 lbs per inch of material with a web width of 2 inches. Can you use this sling?
 - A. Yes
 - B. No
3. You go back to the air conditioning unit, and notice that there are four unshouldered eyebolts at the four corners of the air conditioning unit. Can you perform the lift using two wire-rope slings with mechanical splices and independent wire-rope cores, running from the crane hook to two opposing corners of the air conditioner? The slings available are 3/4" in diameter and would place an angle between the horizontal surface of the load and the sling of 45°.
 - A. Yes
 - B. No
4. Is it true that by using a 4-leg bridle sling configuration, you can double the capacity of what you can lift using the same scenario as question #3? In other words, can you perform the lift by using four 1/2" diameter mechanical splice independent wire-rope core wire-rope slings, running from the crane hook to each unshouldered eyebolt?
 - A. Yes
 - B. No

5. You decide to increase the angle between the horizontal surface of the load and the sling from 45° to 60° by using a six ton spreader beam 12 feet in length. You attach the spreader beam to the crane hook, running it parallel and centered along the length of the air conditioning unit. Two of the $1/2$ " wire-rope slings will be attached to hooks on one end of the spreader beam, running down to the eyebolts, and two will be attached to the other end in a similar manner. Can you perform the lift?
- A. Yes
B. No
7. This means a 10,000 pound air conditioner would require a shouldered eyebolt with minimum diameter of?
- A. $1/4$ "
B. $7/8$ "
C. $3/4$ "
D. 1"
E. $1\ 1/2$ "
6. You replace the unshouldered eyebolts with shouldered eyebolts. At an angle of 60° between the horizontal surface of the load and the four $1/2$ " slings, the load capacity of the eyebolt is reduced by:
- A. 75%
B. 65%
C. 45%
D. The load capacity is not reduced.
8. Is the overall weight of the air conditioner divided in two, if using two slings in a two-leg sling configuration at each end of a spreader beam? In other words, can I use four $7/16$ " diameter mechanical splice independent wire rope slings in two 2-leg sling configurations running from the hooks at the ends of the 12' spreader beam to the shouldered eyebolts, at a 60° angle between the horizontal surface of the load and the slings, if this configuration is capable of lifting 5,800 pounds?
- A. Yes
B. No

9. Could you lift, using a 10 ton crane, a 10,000 pound air conditioner, 10' wide by 12' long by 5' high, with four shouldered eyebolts 1 1/2" in diameter installed at each corner of the air condition, using a 500 pound spreader beam 12' in length, attaching the spreader beam to the crane hook, running it parallel and centered along the length of the air conditioning unit, with four 7/16" diameter mechanical splice independent wire rope slings in two 2-leg sling configurations running from the hooks at the ends of the 12' spreader beam to the shouldered eyebolts, at a 60° angle between the horizontal surface of the load and the slings?

- A. Yes
- B. No

10. Match the rigging component with the appropriate reference page and/or table from WVDP-082.

- A. Mechanical Splice (IWRC)
Wire-Rope Slings
- B. Spreader Beams
- C. Unshouldered Eyebolts
- D. Nylon Double Ply Web Slings
supporting 9,000 lbs per inch of
material
- E. Capacity of a 4 leg bridle hitch
- F. Relationship of load angle and lifting
efficiency
- G. Safe loading of eyebolts - shoulder
type only

ANSWERS

- 10.
- A. Pages 14-2 to 14-6
 - B. Table 11-6
 - C. Figure 11-7
 - D. Table 11-15
 - E. Figure 11-11
 - F. Page 12-13.
 - G. Page 12-11

REVIEW QUESTIONS

HOISTING AND RIGGING PRACTICES

- 1. To avoid additional stresses, quick changing of the velocity of the load should be performed when hoisting.**
 - A. True
 - B. False

- 2. To control the load, hand contact should be maintained.**
 - A. True
 - B. False

- 3. Protectors, softeners and blocking shall be used at sharp corners.**
 - A. True
 - B. False

- 4. The inspection tag is not required to be attached to sling.**
 - A. True
 - B. False

- 5. The weight of the load is not needed prior to the lift.**
 - A. True
 - B. False

- 6. High winds do not have any effect on outdoor rigging operations.**
 - A. True
 - B. False

7. **Loads can be carried or left suspended over personnel.**
- A. True
 - B. False
8. **When rigging a load for a high lift, what precautions should be observed?**
- A. Make all personnel stand clear
 - B. rope off the area
 - C. Never work under a load
 - D. All of the above
9. **The lifting capacity of a synthetic web sling is the same for a straight, choker or basket hitch.**
- A. True
 - B. False
10. **When using a three or four legged bridle sling, the load is carried equally on each leg.**
- A. True
 - B. False
11. **High temperatures or very low temperatures (below 0 degrees F) have no effect on wire or synthetic slings when lifting loads.**
- A. True
 - B. False

HAND SIGNALS

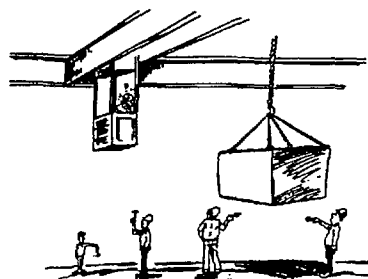

Signals should be given by one person only.



THE STANDARD overhead crane and hoist hand signals adopted by ANSI standards are to be used. If compliance with these hand signals is impractical for the job being performed, other hand signals shall be agreed on by the operator and signal person. Radio communication may be substituted for hand signals when agreed on between the operator and the signal person.

No crane or hoist movement shall be made unless signals are clearly understood. The operator shall respond to signals only from the designated signal person. However, a stop signal shall be obeyed regardless of who gives it.

Tips when using hand signals:

- 1) Exaggerate each signal and make a distinct move when choosing to STOP that command before going to the next action.
- 2) The operator should be able to see the signaler and the load within the same field of view when not operating in the blind.
- 3) The signaler should train himself/herself to perform signals in an exact repeatable fashion. (Every "Hoist the Load" signal he/she gives should look exactly alike). This will reduce or eliminate confusion between signaler and operator.
- 4) When signaling for the operator to "travel" on an overhead crane, anticipate and give the STOP signal in advance so that the load doesn't pass beyond its landing spot.

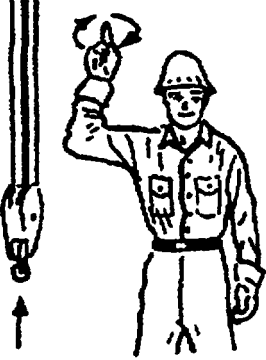
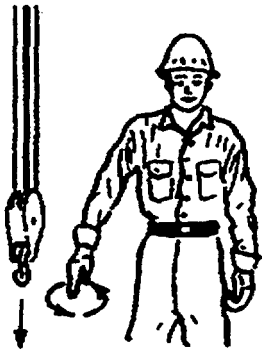
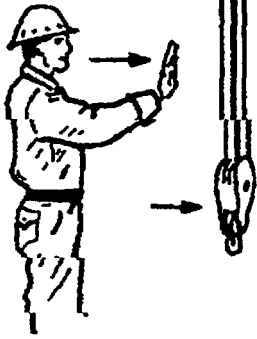
HAND SIGNALS - OVERHEAD CRANES: WORKSHOP

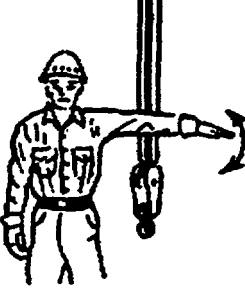
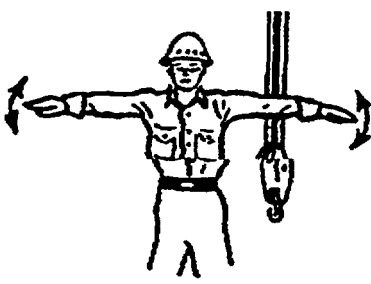
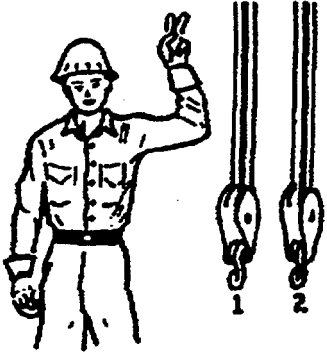
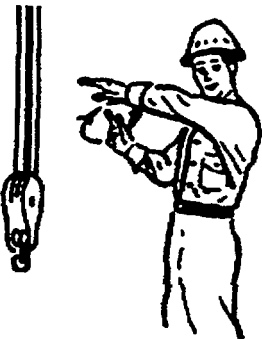
 <p>HOIST With forearm vertical, forefinger pointing up, move hand in small horizontal circle.</p>	 <p>LOWER With arm extended downward, forefinger pointing down, move hand in small horizontal circles.</p>	 <p>BRIDGE TRAVEL Arm extended forward, hand open and slightly raised, make pushing motion in direction of travel.</p>
 <p>TROLLEY TRAVEL Palm up, fingers closed, thumb pointing in direction of motion, jerk hand horizontally</p>	 <p>STOP Arm extended, palm down, move arm back and forth.</p>	 <p>EMERGENCY STOP Both arms extended, palms down, move arms back and forth.</p>
 <p>MULTIPLE TROLLEYS Hold one finger for block marked "1" and two fingers for block marked "2". Regular signals follow.</p>	 <p>MOVE SLOWLY Use one hand to give any motion signal and place other hand motionless in front of hand giving the motion signal. (Hoist slowly given as example.)</p>	<p><i>Bridge Travel</i></p> <p><i>Carrier or Trolley Travel</i></p> <p><i>Emergency Stop</i></p> <p><i>Hoist</i></p> <p><i>Lower</i></p> <p><i>Move Slowly</i></p> <p><i>Multiple Trolleys</i></p> <p><i>Stop</i></p>

Standard Signals

The standard signals for DOE use shall be as specified in the latest edition of the American National Standards Institute (ANSI) B30 chapters, for the particular type of crane or hoist being used.

Identification of Signalers

- a) All personnel acting as signalers during crane operations shall be clearly identified to the crane operator by the use of the following (one or more, as required by the cognizant manager): orange hardhat; orange gloves; and/or orange vest. At WVNS, riggers are required to wear orange vests when lifting outside. Additionally, the orange rain coat used during inclement weather may be used in lieu of the orange vest. Also, a hat or orange gloves must be used by the signaler(s) for identification purposes. This requirement may be waived by the cognizant manager when the lift is very closely controlled or personnel are required to wear special clothing for protection from a hazardous environment.
- b) In those cases where the crane operator cannot see the signaler, a second person (relay signaler) shall be stationed where he/she can see both the signaler and the crane operator and relay the signals to the operator.

- c) Where voice (direct or two-way radio) communication is used, the signaler shall communicate directly with the operator: not through a third person.
- d) The operator shall recognize signals only from the designated signaler, except that a signal for a stop shall be obeyed when given by anyone.

INCIDENTAL HOISTING OPERATOR OBJECTIVES

KNOWLEDGE OBJECTIVES

- State the qualification requirements for incidental crane operators.
- Identify the main components of the hoist and crane.
- Explain what inspection should be performed on the equipment prior to use.
- Describe the hand signals used during lifting operations.
- Explain what a side pull is and how it is possible to damage equipment.
- Explain what safe working practices to consider when using hoists and cranes.

HOISTS

48 Pendant Operated

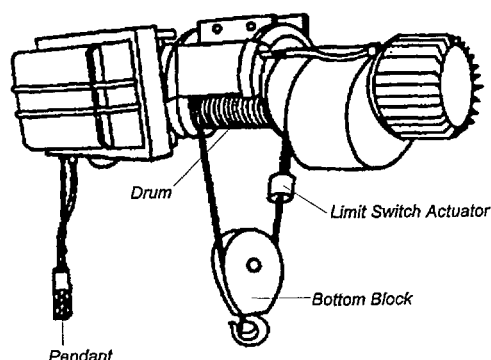

49 Rigging a Chainfall

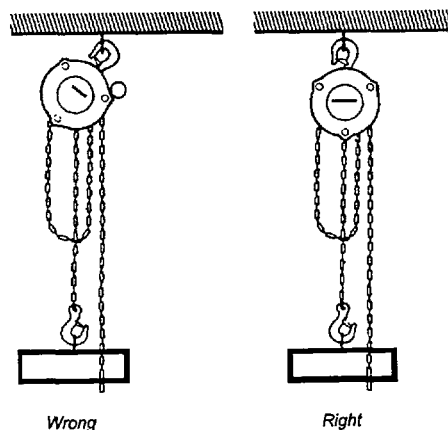

Hoist can be electric-powered, ai-powered or hand-powered and are not permanently mounted. The requirements for Hoists are in Section 8.0 of the *DOE Hoisting and Rigging Manual*.

ELECTRIC-POWERED HOIST – *pendant operated*, controls will return to off position when released and motion stops (48).

AIR-POWERED HOIST – *pendant operated*, controls will return to off position when released and motion stops.

HAND CHAIN OPERATED – *manual*, designed to automatically stop and hold load when lifting force is removed.

Chain hoists should be rigged so that there is a straight line between the upper and lower hooks. They are intended for use in a vertical or near vertical position only. If rigged at an angle, the upper hook can be damaged at the shank and the throat may open up. If the gear housing is resting against an object while under load it can be damaged or broken (49).

Always make sure that the hoist is hanging freely.

HOIST TERMINOLOGY

BOTTOM BLOCK – (load block) – The assembly of hook or shackle, swivel, bearings, sheaves, pins and frame suspended from the hoisting ropes or chains.

LIMIT SWITCH – Device which restricts the raising and lowering capabilities of the hoist through altering the electrical circuit associated with that hoist.

* **NOTE:** When no lower limit switch is provided, **not less than two full wraps** of rope shall remain on the hoist drum when the hook is in its fully extended position.

Upper limit switch - contact device which restricts the upward travel of the hoist based on counting revolutions on drum or when the block contacts a device below the hoist drum.

Lower limit switch - contact device restricting the downward travel of the hoist based on counting revolutions on drum, in which case the LLS ensures one full wrap* of rope shall remain on the hoist drum when the hook is in its fully extended position.

Pendant Control - Components

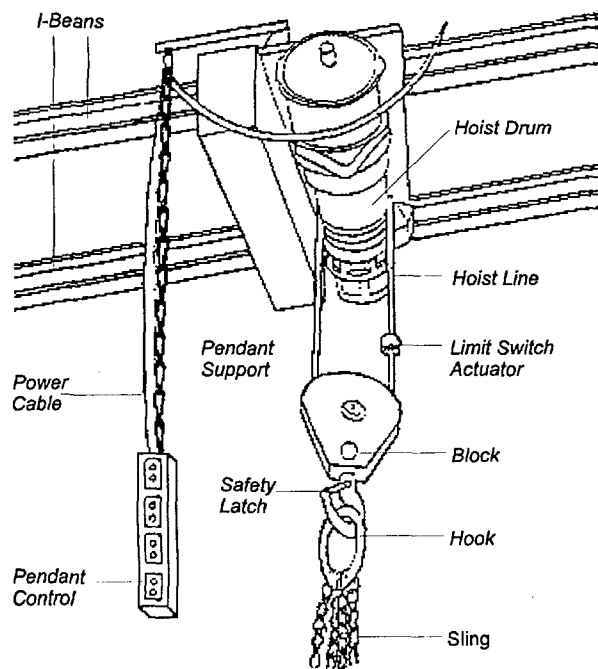

PENDANT STATION – Controls suspended from the hoist for operating the unit from the floor.

DRUM – A Cylindrical-flanged barrel on which the wire rope is wound for operation or storage. It may be smooth or grooved.

Review the requirements as outlined in Section 8.0 of the DOE H&R Manual.

OVERHEAD AND GANTRY CRANES

The larger cranes are mostly of the *overhead* type controlled by a **pendant** which hangs from the crane. The pendant controls the hoist motion and bridge and trolley travel.

The various types of cranes are described in Section 7.0 of the *DOE Hoisting and Rigging Manual*.

Review Section 7.0, "Overhead and Gantry Cranes" in the DOE H&R Manual.

The inspection criteria is outlined in SOP 15-56, "Inspection Mechanized Hoisting Equipment." Each crane is inspected monthly by maintenance and is noted on the inspection tag.

49

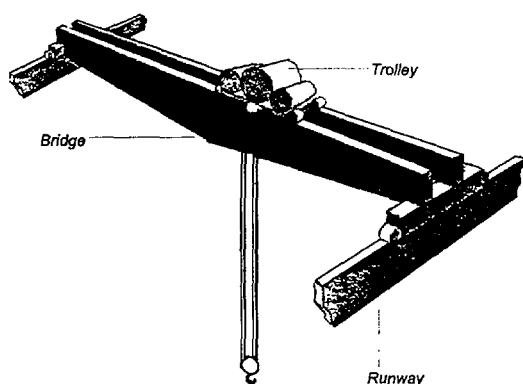

BASIC COMPONENTS OF AN OVERHEAD TRAVELING CRANE

There are many types of overhead traveling cranes, but their *three basic components* are similar:

- Runway
- Bridge
- Trolley

The **RUNWAY** resembles a railroad track. It is made of rails, beams, girders, and brackets, providing the framework and support for the crane.

The **BRIDGE** travels on the runway. The bridge is made up of two or more girders, trucks (wheels), and a drive mechanism to move the bridge along the runway (49).

TROLLEY AND TROLLEY PARTS

The **TROLLEY** is carried by the bridge and *moves horizontally* between the runways, providing support for the hoist mechanism.

The **HOIST MECHANISM** consists of the **LOAD BLOCK** (sometimes referred to as the lifting block) and drum. Wire ropes connected to the drum and threaded through the load block are used to raise and lower the load (50).

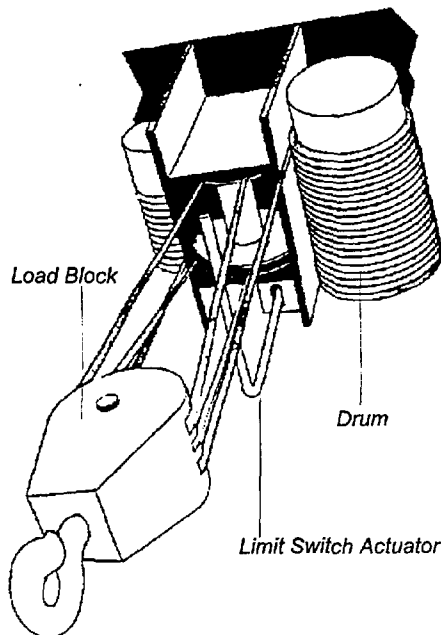

The wire rope is wrapped around a motor-driven **DRUM** as the load is lifted. This rope is then played out as the load is lowered. The drum also provides a storage area, reducing the possibility of damage to the wire rope.

As the load is raised to the end of the load block travel, it comes in contact with a **LIMIT SWITCH ACTUATOR**. This limit switch stops the travel of the block, preventing the crane from being damaged and the load from being dropped.

Bridge Crane Components and Movements

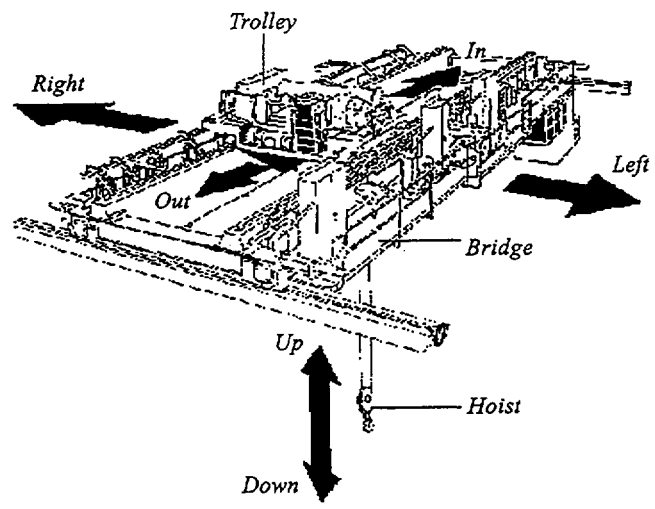
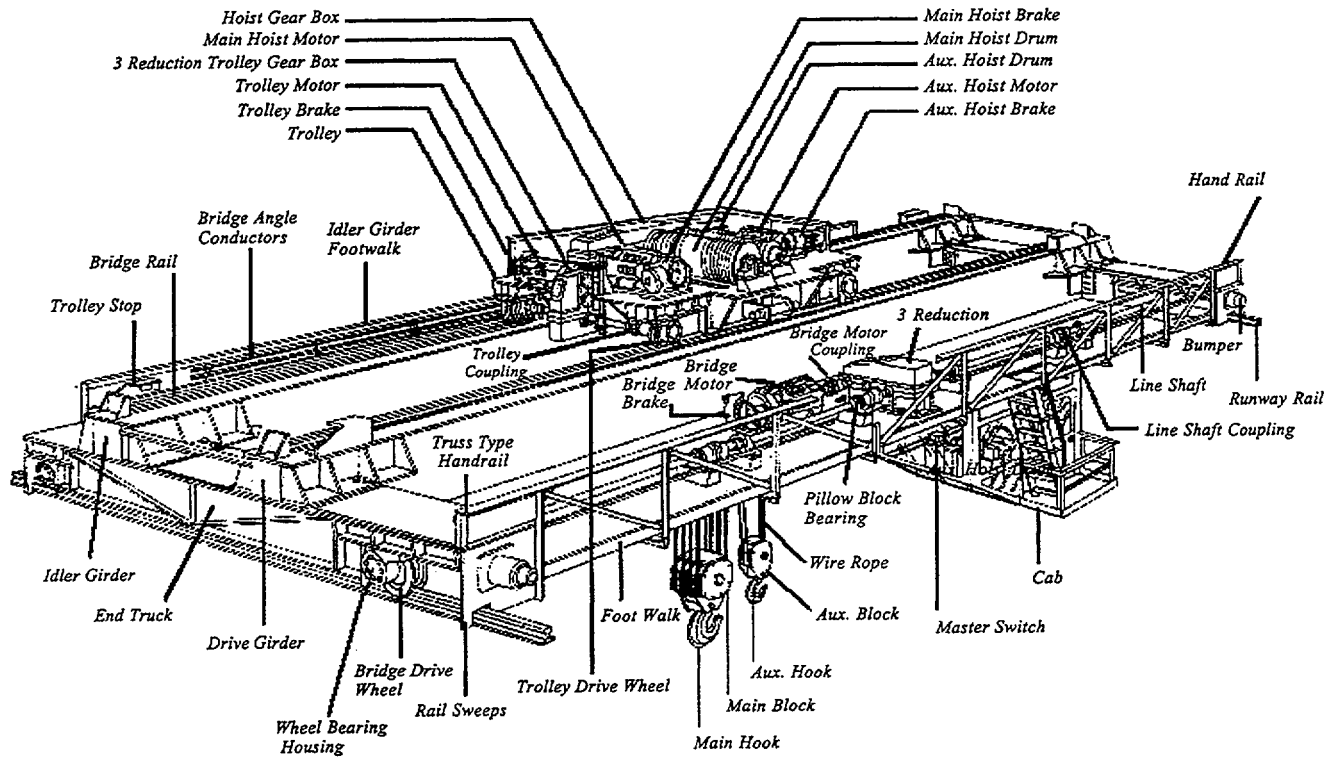

REVIEW QUESTIONS**HOISTS AND OVERHEAD CRANES**

- 1. A hoist wire rope can be used as a ground for welding.**
 - A. True
 - B. False

- 2. The hoist wire rope or chain can be used to wrap around the load for a lift.**
 - A. True
 - B. False

- 3. All controls shall be tested by the operator prior to operation of the hoist or crane at the beginning of the shift.**
 - A. True
 - B. False

- 4. When there is any question as to the safety of the activity, the crane operator has the authority to stop or refuse to handle loads.**
 - A. True
 - B. False

- 5. To avoid a side pull, the hook should be centered over the center of gravity of the load.**
 - A. True
 - B. False

6. **SOP 15-56**
What personal protection equipment is required to be worn when conducting or observing a load test.
- A. Shoes
 - B. Hard hat
 - C. Glasses
 - D. Safety glasses, steel toe shoes and hard hat
7. **SOP 15-56**
Prior to use of the hoist or crane each day the operator shall perform a daily check of the equipment.
- A. True
 - B. False
8. **SOP 15-56**
Daily check by the operator will include:
- A. Brakes, control mechanism, hoist rope
 - B. Warning device, lights, guards
 - C. Safety devices
 - D. All of the above
9. **If a load becomes unbalanced, lower and rebalance the load, it should not be lifted more than a few inches until it is properly balanced.**
- A. True
 - B. False
10. **When a lower-limit device is not provided, the loaded hoist drum shall not be rotated in the lowering direction beyond how many wire-rope wraps on the drum.**
- A. One-Half
 - B. One
 - C. Four
 - D. Two
11. **The hoist-limit switch which controls the upper limit of travel of the load block shall never be used as a normal operation control.**
- A. True
 - B. False
12. **Matching - Fill in the blanks with the correct letter next to the proper description:**
- ___ Main Block
 - ___ Bridge Rail
 - ___ Rail Sweeps
 - ___ Bumper
 - ___ Trolley
 - ___ Trolley Stop
 - ___ Aux. Block
 - ___ Runway Rail
 - ___ Bridge Drive Wheel

MOBILE CRANES

The operation of a mobile crane requires a New York State License. At WVNS, operations personnel will perform rigging of loads to be lifted by a mobile crane. The crane operator is a subcontractor who is licensed by NYS. WVNS personnel will not be operating the mobile crane but only rigging the load to be lifted. You will need to have an understanding of proper operating practices and hand signals.

Crane Working Areas

Model on Tires

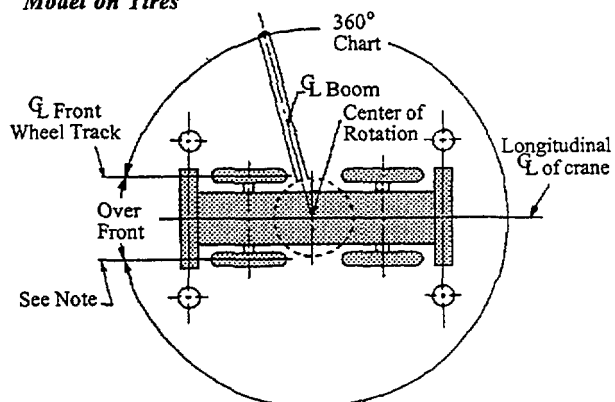

Review *DOE H&R manual*, Section 9, "Mobile Cranes," and Section 15, "Construction Hoisting and Rigging Equipment."

Review the WVNS SOP 15-61, "Inspection of the Link Belt 22-ton Mobile Crane" for specific details on its inspection.

Model on Outriggers

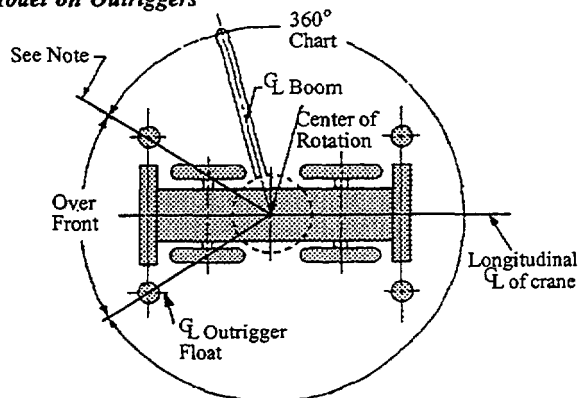

Note: These lines determine the limiting position of any load for operation within working area indicated.

CRANE TIPS WHILE LIFTING LOAD AT HANFORD

On May 30, 1997, at the Hanford Tank Farms, a 30-ton mobile, hydraulic crane lifting a 4,600-pound steel trench box tipped, and the boom landed on a 10-foot mound of dirt. The crane came to rest against the mound at a 45-degree angle. The crane operator and an assisting flagman were not injured. Investigators determined that the crane operator failed to extend all four outriggers as required for this type of lift. Loss of control of the crane could have caused equipment damage or personal injury. (RL-PHMC-TANKFARM-1997-0048)

A subcontractor had excavated a trench and shored it with the steel trench boxes and stacked them for removal. Investigators determined that the operator extended the front two outriggers of the crane, but failed to extend the rear two, when preparing to lift the sections. A typical hydraulic crane, displaying the outrigger configuration, is shown in Figure 4-1.

The operator picked up the load and extended the boom. As he rotated the load to the side of the crane, the crane fell against the mound of dirt (see Figure 4-2). The operator shut down the crane and exited without injury.

Investigators determined that the load rating chart for the crane permitted lifts without extended outriggers. However, the allowable load, boom angle, and extension are greatly reduced. The load chart does not address operating the crane with only two outriggers extended. According to the load chart, the capacity and geometry of the lift were acceptable with all outriggers extended. Investigators determined that the crane operator failed to properly configure the crane for the lift.

HAND SIGNALS - MOBILE CRANES

<p>HOIST With forearm vertical, forefinger pointing up, move hand in small horizontal circles.</p>	<p>LOWER With arm extended downward, forefinger pointing down, move hand in small horizontal circles.</p>	<p>use main hoist Tap fist on head; then use regular signals.</p>	<p>Use whipline (Auxiliary Hoist). Tap elbow with one hand, then use regular signals.</p>
<p>Raise Boom Arm extended, fingers closed, thumb pointing upward.</p>	<p>Lower Boom Arm extended, fingers closed, thumb pointing downward.</p>	<p>Move slowly Use one hand to give any motion signal. Place other hand, motionless, in front of hand giving motion signal.</p>	<p>Raise Boom & Lower Load With arm extended, thumb pointing up, flex fingers in & out as long as load movement is desired.</p>
<p>Lower Boom & raise Load With arm extended, thumb pointing down, flex fingers in & out as long as load movement is desired.</p>	<p>Swing Arm extended, point with finger in direction of swing of boom.</p>	<p>stop Arm extended, palm down, hold position rigidly.</p>	<p>emergency stop Both arms extended, palms down, move arms back and forth horizontally.</p>
<p>travel Arm extended forward, hand open and slightly raised, make pushing motion in direction of travel.</p>	<p>Dog everything Clasp hands in front of body.</p>	<p>Travel (Both Tracks). Use both fists in front of body, making a circular motion about each other, indicating direction of travel; forward or back. (For land cranes)</p>	<p>Travel (One Side Track). Lock the track on side indicated by raised fist. Travel opposite track indicated by circular motion of other fist, rotated vertically in front of body. (Land cranes only)</p>
<p>extend boom (Telescoping Booms). Both fists in front of body with thumbs pointing outward.</p>	<p>Retract boom (Telescoping Booms). Both fists in front of body with thumbs pointing toward each other.</p>	<p>extend boom (Telescoping Boom). One hand signal. One fist in front of chest with thumb tapping chest.</p>	<p>Retract boom (Telescoping Boom). One hand signal. One fist in front of chest with thumb pointing outward & heel of fist tapping chest.</p>

REVIEW QUESTIONS

MOBILE CRANES

- 1. Load can be moved over personnel in the hoisting area.**
 - A. True
 - B. False

- 2. Work can be conducted under suspended loads under normal conditions.**
 - A. True
 - B. False

- 3. To reduce the load swinging when lifted the hook should be positioned over the center of gravity of the load.**
 - A. True
 - B. False

- 4. An ordinary lift with more than one person requires a designated leader.**
 - A. True
 - B. False

- 5. A person-in-charge (PIC) is required for a critical lift.**
 - A. True
 - B. False

APPENDIX**SUBCONTRACTOR EMPLOYEE FATALLY
INJURED IN TANK MOVING OPERATION**

On November 14, 1992, an employee of Chemical Waste Management, Inc. (CWM) was critically injured when one of the two straps around a tank being lifted failed, allowing the tank to fall and strike the employee. The employee died as a result of those injuries on November 19, 1992. This incident occurred at the Oak Ridge K-25 Site in Oak Ridge, Tennessee.

Following is a summary of the direct, primary and secondary contributing and root causes as described in the Type A Investigation of the accident, which was carried out at the direction of the DOE Oak Ridge Field Office. Also included are lessons learned, and comparisons of potential situations at the West Valley Demonstration Project.

The details of the accident, root causes and lessons learned should be discussed at all operations groups workplace meetings. All hands should be reminded that they are empowered, and directed, to stop any jobs they believe are unsafe, and bring the conditions to the attention of their supervisor for correction.

Accident Description

On Friday, November 13, 1992, two 6800-gallon polyethylene tanks arrived at the Pond Waste Management Project (PWMP - part of the K-25 Site), were off-loaded from the delivery truck by forklift, and were rolled into the work area by hand. The next day (Saturday), preparations began for lifting the first of the two tanks into a bermed area for installation. The lower ends of two synthetic lifting slings were shackled to two synthetic tie-down straps encircling the tank. The upper ends of the two slings were then attached via a third synthetic sling to one time of an extendable-boom "Skytrak" (trade name) forklift. As the tank was being lifted by the Skytrak into the berm, several of the workers, including the accident victim, moved into the berm to position the tank. As the tank was passing over the berm wall, one of the tie-down straps failed at a preexisting flaw. The tank fell, struck the berm wall, bounded into the berm, and struck the victim, injuring him. He died five days later.

Findings of the DOE Investigation

Direct Cause:

The direct cause of the accident was determined to be the failure of the tie-down strap used to rig the storage tank for lifting. (The inappropriate use of the tie-down strap for lifting is discussed in detail under contributing causes.)

Contributing Causes (primary)

1. *The Rigging Equipment Selected Was Improper:* Two 2-inch tie-down straps were used as lifting slings around the tank. It was determined during the investigation that the strap that failed had a preexisting .6" cut, and it was at this point that it failed. A boomed forklift was used to hoist the tank, but the manufacturer's specifications state it is not to be used in that type of application ("DO NOT travel or turn with the boom up." To hoist the tanks into place, the Skytrak was required to travel with the boom in an elevated and extended position. The tag on the failed tie-down strap was marked, "This tie-down assembly is not to be used for lifting." The lifting slings which were used to rig the tank to the forklift did not have legible tags.
2. *Personnel Were Not Separated in Space From the Suspended Load:* Tag lines were not used to assist in maneuvering the load. Five employees were inside the bermed area where the tank was being placed, and were in close proximity to the load. The victim was less than seven feet away.
3. *Tie-Down Straps Were Deteriorated and Flawed:* The strap which failed was found to have a preexisting flaw of .6 inches which was found, through laboratory testing of similar straps, to have reduced its tensile strength to 2350 pounds. Investigators calculated that the tensile load on the failed strap was 2370 pounds (dynamic forces were not considered in this calculation). Witnesses stated that one of the straps had a preexisting flaw, but it was used in spite of that fact.

4. *Lines of Supervision Were Not Clear:* The subcontractor operational chain of command differed significantly from the formal organization chart. There was considerable confusion regarding who was directing the tank moving operation.

5. *On-the-Job Hazard Recognition Was Less Than Adequate (LTA):* The actual weight of the tank was not known. Tie-down straps were used instead of slings. Employees were allowed to be too close to a suspended load. Employees did not realize that approximately 150 gallons of water remaining in the tank from a static lead test added approximately 1180 pounds to the weight of the tank. Subcontractor (CWM) management did not expect line supervision to look for or identify job and safety hazards.

6. *Hazard Underestimated by Subcontractor Management:* There was not specific pre-job briefing held prior to the tank moving operation. There was not single person-in-charge (PIC). Employees involved in the operation each had a different understanding of the lifting sequence. The forklift operator did not see the workers enter the berm under the suspended load.

Three of the five workers in the berm did not attend the morning safety briefing. In fact, the morning safety briefing DID NOT COVER any of the days scheduled work, including the tank moving operation. Site safety personnel were not aware of the operation. No subcontractor safety personnel were present during the moving operation.

Responsible subcontractor managers were not on-site that day (Saturday). WORKERS WHO WERE NOT TRAINED IN HOISTING AND RIGGING WERE ASSIGNED TO THE JOB.

7. *Work Controls Were LTA:* There was not a proper work document for the operation; only a "maintenance work order" with a short narrative description and hand-drawn sketches. This maintenance work order included no procedure, safety precautions, acceptance criteria, quality assurance, or signature for acceptance by the customer. The sketches provided were not sufficient to complete the job and had to be supplemented by oral instructions at the job site.

8. *Roles and Responsibilities Were Not Understood by Employees:* Employees at the job site did not clearly understand who was in charge of directing the tank movement operation, and who decided to use the tie-down straps for rigging. Personnel involved with the job did not receive any pre-job briefing; consequently, the workers did not understand what task they were to perform.

There was a total of three subcontractor companies involved in the tank operation: Chemical Waste Management, Inc. (CWM), Rust International Corporation (Rust), and Veterans Steel Erection Co. (Veterans). THE RESPONSIBILITY FOR RIGGING AND MOVING THE TANK RESTED WITH VETERANS. The Veterans employees stated that they were there to assist CWM in placing the tank. CWM employees stated they were there to assist Veterans with placement of the tank.

9. *Schedule pressure emphasized production:* Workers stated there was enormous pressure to meet critical deadlines (driven by regulatory agencies). The subcontractor (CWM) was working on a seven-day work week, and workers averaged over 50 hours of overtime per two-week pay period. It was widely believed that, if the schedule was missed, the subcontractor would lose future opportunities for additional contracts at Oak Ridge.

10. *Subcontractor Project Planning and Management Were LTA:* The CWM weekend work activities were normally planned at a Wednesday morning meeting. The tanks were delivered late on Friday, and subsequently, the tank moving operation was not included on the published schedule. Other than the inadequate "maintenance work document," all work instructions were given orally. CWM management did not emphasize safety over production schedules.

ANSWER KEY

**OPERATOR TRAINING AND
QUALIFICATIONS**

Wire Rope Sling

1. A
2. B
3. B
4. C

Synthetic Web Sling

1. B
2. D
3. B
4. B

Chain Slings

1. A
2. B
3. A

Spreader Beams

1. B
2. B
3. A

Rigging Hardware

1. A
2. A
3. A
4. A
5. B
6. A
7. A
8. A
9. A
10. A
11. A
12. A
13. B
14. A
15. D

Critical Lift

1. Reference Page 40.
2. A
3. Reference Page 41.

General Rigging Practices

1. B
2. B
3. A
4. B
5. B
6. B
7. B
8. D
9. B
10. B
11. B

Hoists and Overhead Cranes

1. B
2. B
3. A
4. A
5. A
6. D
7. A
8. D
9. A
10. D
11. A
12. F, B, E, I, A, C, G, H, D

Mobile Cranes

1. B
2. B
3. A
4. A
5. A